

Thermal Interface Materials for Electronics Cooling

Products & Custom Solutions Catalog



ENGINEERING YOUR SUCCESS.

Parker Chomerics Thermal Interface Material Offerings

Gap Fillers come in two different types, gels and pads. Gels are low-closure-force, electrically isolating, fully cured materials that are dispensed into place. Gap filler pads are low-closure-force thermal pads designed to accommodate a wide gap range and electrical isolation.

Phase Change Materials are thin pads that are placed between a heatsink and the IC chip that then change phase into a liquid at higher temperatures to achieve a thin bond line for better thermal performance. Poly solder hybrid (PSH) materials consist of both binder and fillers which both change phase.

Thermal Tapes have adhesive on both sides to hold a heat sink in contact with an IC component.

Potting and Underfill Materials are one- or two-component materials that are dispensed and then cured in place afterwards (unlike thermal gap filler gels, which are already cured when dispensed).

Dielectric Pads are higher-closure-force pads specifically designed to be electrically isolating, also known as a dielectric, as well as being thermally conductive. Dielectric pads are typically used on power transistors that have an electrically energized base that will short out if made to directly contact a metal heat sink.

Heat Spreaders utilize two different vehicles of thermal transfer: conduction to pull heat off an integrated circuit, and convection to use air flow over the product to remove that heat from the assembly.

Thermal Greases are silicone-based pastes with a thermally conductive filler material meant to draw heat away from a heat-generating component on a circuit board while filling very thin bond lines.

Thermal Management Products & Custom Solutions

Thermal Gels	8
Gap Filler Pads	12
Phase Change Materials	23
Thermal Tapes	25
Potting and Underfill Materials	29
Dielectric Pads	33
Heat Spreaders	41
Thermal Greases	46
Dispensing Guide	49
Heat Transfer Fundamentals	64
Glossary	68

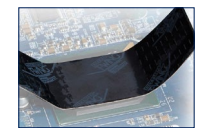
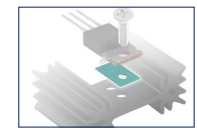
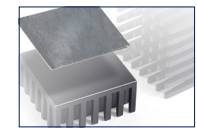
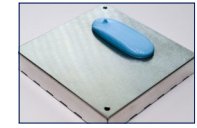

Introduction

Parker Chomerics is a global provider of EMI shielding and thermal interface materials as well as electrically conductive thermoplastics and optical products.

Parker provides products and services to OEM and CEM electronics companies in the telecommunications, information technology, consumer, power conversion, medical device, defense and transportation markets.

As each new electronic product generation requires higher power in smaller packages, the challenges associated with thermal management become more intense. Parker is committed to developing new, high-performance products to meet the thermal and design challenges of tomorrow's systems. Thermal material drivers include:

- Lower thermal impedance
- Higher thermal conductivity
- Greater compliance and conformability
- High reliability
- Greater adhesion
- Ease of handling, application and use
- Long service life

Parker Chomerics' drive to support our customers is also based on our continuing commitment to:

- Thermal materials expertise
- Comprehensive applications engineering
- Optimized supply chain and logistics
- Worldwide fabrication and service

About Parker Hannifin Corporation

Parker Hannifin (NYSE:PH) is the world's leading diversified manufacturer of motion and control technologies and systems, providing precision-engineered solutions for a wide variety of mobile, industrial and aerospace markets. The company's products are vital to virtually everything that moves or requires control, including the manufacture and processing of raw materials, durable goods, infrastructure development and all forms of transport. Parker is strategically diversified, value-driven and well positioned for global growth as the industry consolidator and supplier of choice.



TIMs for Military and Aerospace Applications



TIMs for Light Emitting Diode (LED) and Industrial Applications



Gap Filler Pad and Dispensed Gels for Telecommunications



Dispensed Gels in Automotive Electronic Control Unit (ECU) Applications

Thermal Management Materials Selector

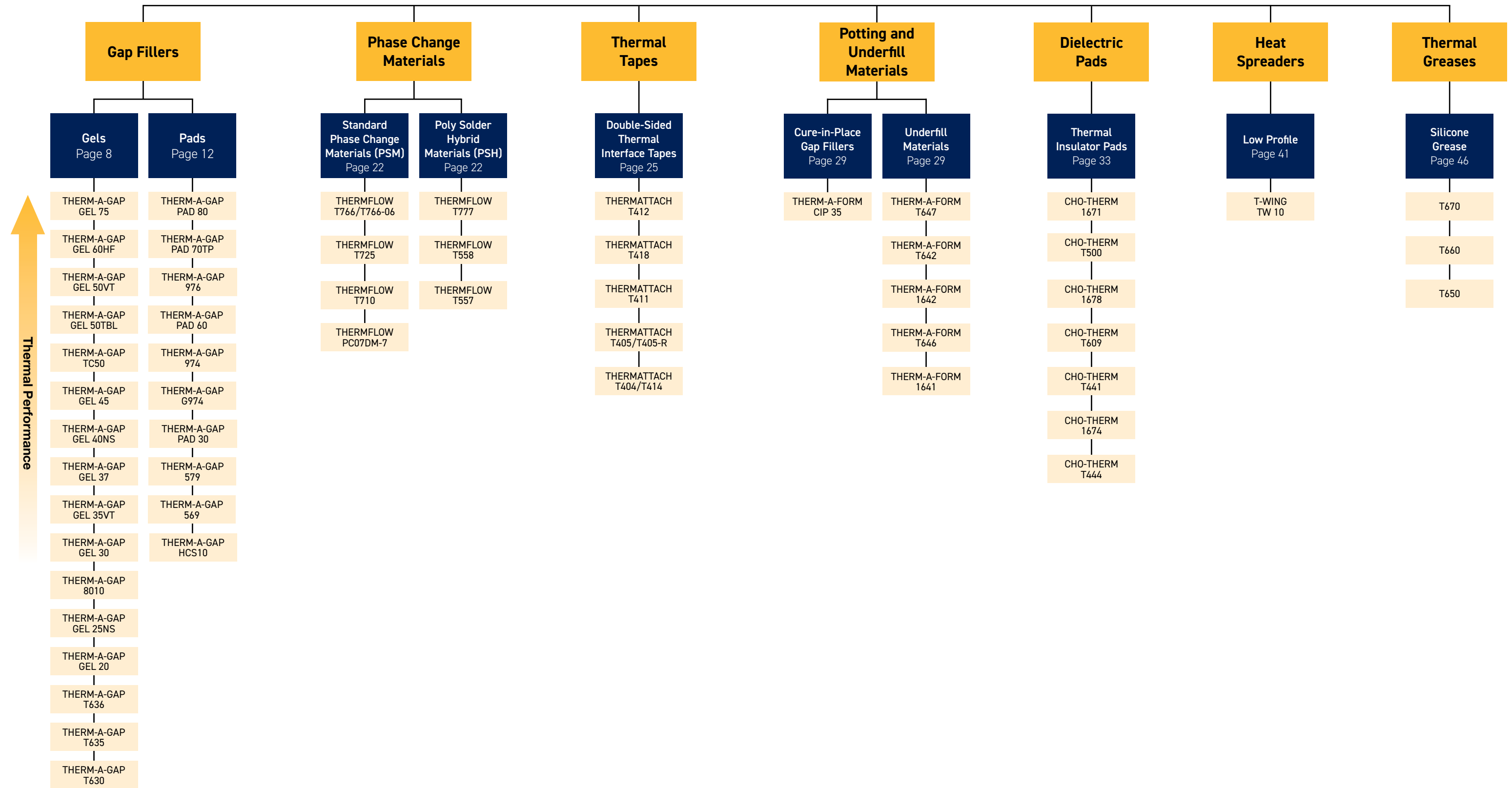

THERM-A-GAP™ Gels

Dispensable, Very Low Compression Force, Thermal Gap Fillers



THERM-A-GAP™ Gels are highly conformable, pre-cured, single-component compounds. The cross-linked gel structure provides superior long term thermal stability and reliable performance.

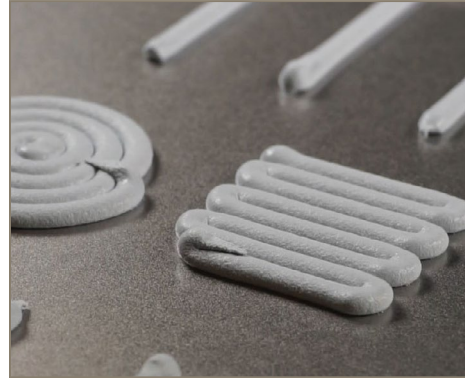

FEATURES / BENEFITS

- Dispensable
- Fully cured
- Highly conformable at low pressures
- Vertical orientation of cartridge during storage
- Single dispensable TIM can eliminate multiple pad part sizes/numbers
- Reworkable

TYPICAL APPLICATIONS

- Automotive electronic control units (ECUs)
 - Engine control
 - Transmission control
 - Braking/traction control
- Power conversion equipment
- Power supplies and uninterruptible power supplies
- Power semiconductors
- MOSFET arrays with common heat sinks
- Televisions and consumer electronics

PERFORMANCE GUIDE

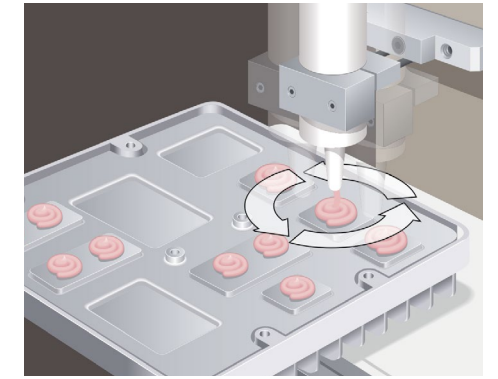
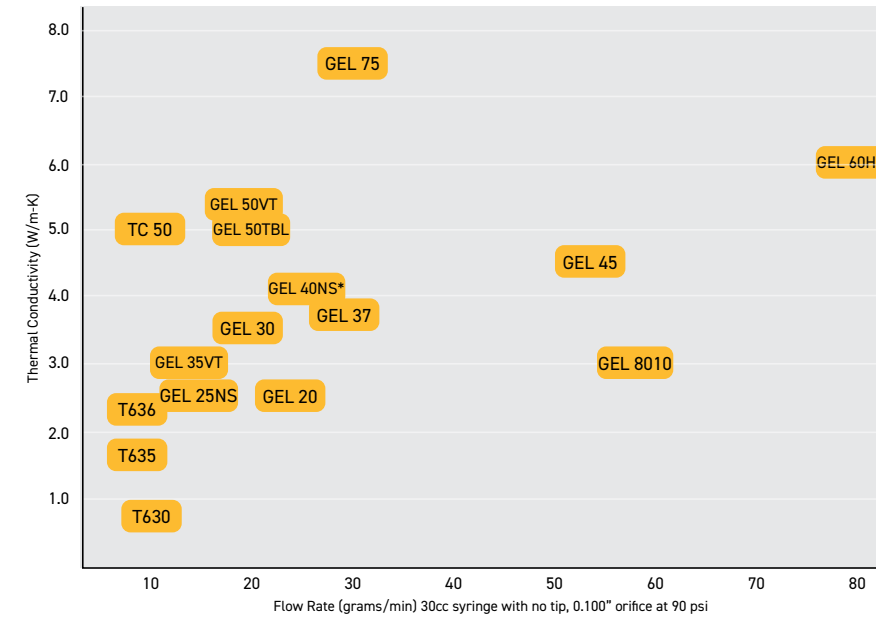

Consult Applications Engineering for automated dispensing equipment recommendations.

* THERM-A-GAP GEL 40NS flow rate is measured through a 0.170" diameter orifice.

THERM-A-GAP™ Thermally Conductive Gels

Typical Properties [†]	GEL 20	GEL 25NS	GEL 30	GEL 35VT	GEL 37	GEL 40NS
Physical						
Color	Dark Blue	Yellow	Pink	White	Blue	Dark Gray
Binder	Silicone	Urethane	Silicone	Silicone	Silicone	Urethane
Flow Rate, grams/min - 30 cc syringe with no tip attachment, 0.100" orifice, 90 psi (621 kPa)	24	15	20	16	30	25 - 35*
Specific Gravity	2.85	2.6	3.1	2.9	3.1	3.1
Typical Minimum Bondline Thickness, in (mm)	0.004 (0.10)	0.004 (0.11)	0.004 (0.10)	0.004 (0.10)	0.004 (0.10)	0.006 (0.15)
Thermal						
Thermal Conductivity, W/m-K	2.4	2.5	3.5	3.5	3.7	4.0
Heat Capacity, J/g-K	1.25	1	1	1	1	1
Operating Temperature Range, °F (°C)	-67 to 392 (-55 to 200)	-58 to 257 (-50 to 125)	-67 to 392 (-55 to 200)	-67 to 392 (-55 to 200)	-67 to 392 (-55 to 200)	-58 to 257 (-50 to 125)
Electrical						
Dielectric Strength, Vac/mil (kVac/mm)	200 (8)	200 (8)	200 (8)	200 (8)	180 (7)	200 (8)
Volume Resistivity, ohm-cm	10 ¹²	10 ¹⁴	10 ¹⁴	10 ¹³	10 ¹⁴	10 ¹⁴
Dielectric Constant @ 1000 kHz	4	6.7	7.0	4.6	5.9	4.8
Dissipation Factor @ 1000 kHz	0.003	0.018	0.002	0.002	0.012	0.020
Regulatory						
Flammability Rating	V-0	V-0	V-0	V-0 (Tested by Chomerics)	V-0	V-0
RoHS Compliant	Yes	Yes	Yes	Yes	Yes	Yes
Outgassing, % TML (% CVCM)	0.127 (0.06)	0.23 (0.04)	0.15 (0.05)	TBD	0.18 (0.07)	0.18 (0.03)
Shelf Life, months from date of manufacture	18	12	18	12	18	12
Storage Conditions, °F (°C) @ 50% Relative Humidity	50 to 90 (10 to 32)	50 to 90 (10 to 32)	50 to 90 (10 to 32)	50 to 90 (10 to 32)	50 to 90 (10 to 32)	50 to 90 (10 to 32)

[†] Typical properties: these are not to be construed as specifications.

* THERM-A-GAP GEL 40NS flow rate is measured through a 0.170" diameter orifice.

** See parker.com/chomerics for [Thermal Interface Material Shelf Life Recertification](#)

GEL 45	GEL 50TBL	GEL 50VT	GEL 60HF	GEL 75	Test Method
Black	Gray	Light Gray	Gray/Black	Light Gray	Visual
Silicone	Silicone	Silicone	Silicone	Silicone	--
55	20	20	80	30	Chomerics
3.1	3.3	3.3	3.3	3.4	ASTM D792
0.0035 (0.0889)	0.002 (0.05)	0.006 (0.15)	0.006 (0.15)	0.008 (0.20)	Chomerics
4.5	5.0	5.2	6.2	7.5	ASTM D5470
1	1	1	1	1	ASTM E1269
-67 to 392 (-55 to 200)	-67 to 392 (-55 to 200)	-67 to 392 (-55 to 200)	-67 to 392 (-55 to 200)	-67 to 392 (-55 to 200)	Chomerics
200 (8)	200 (8)	200 (8)	125 (5)	200 (8)	ASTM D149
10 ¹⁴	10 ¹⁴	10 ¹⁴	10 ¹³	10 ¹⁴	ASTM D257
7.0	3.3	5.2	5.8 / 4.8	7.4	ASTM D150
0.002	0.002	0.003	0.001 / 0.002	0.003	Chomerics
V-0	V-0 (Tested by Chomerics)	V-0 (Tested by Chomerics)	V-0 (Tested by Chomerics)	V-0	UL 94
Yes	Yes	Yes	Yes	Yes	Chomerics Certification
0.23 (0.06)	0.22 (0.08)	0.07 (0.02)	0.14 (0.07)	0.18 (0.05)	ASTM E595
18	12	12	12	18	Chomerics
50 to 90 (10 to 32)	50 to 90 (10 to 32)	50 to 90 (10 to 32)	50 to 90 (10 to 32)	50 to 90 (10 to 32)	Chomerics

THERM-A-GAP GEL Suffix Meanings

- HF: High-Flow
- NS: Non-Silicone
- TBL: Thin Bondline
- VT: Vertical Tackiness

THERM-A-GAP™ Thermally Conductive Gels

	Typical Properties†	T630	T635	T636	GEL 8010	TC50	Test Method
Physical	Color	White	White	Yellow	White	Gray	Visual
	Binder	Silicone	Silicone	Silicone	Silicone	Silicone	--
	Flow Rate, grams/min - 30 cc syringe with no tip attachment, 0.100" orifice, 90 psi (621 kPa)	10	8	8	60	10	Chomerics
	Specific Gravity	2.0	1.5	1.2	2.7	3.25	ASTM D792
	Typical Minimum Bondline Thickness, in (mm)	0.004 (0.10)	0.015 (0.38)	0.015 (0.38)	0.002 (0.05)	0.006 (0.15)	Chomerics
Thermal	Thermal Conductivity, W/m-K	0.7	1.7	2.4	3.0	5.0	ASTM D5470
	Heat Capacity, J/g-K	1.1	0.9	0.9	1	1	ASTM E1269
Electrical	Operating Temperature Range, °F (°C)	-67 to 392 (-55 to 200)	-67 to 392 (-55 to 200)	-67 to 392 (-55 to 200)	-67 to 392 (-55 to 200)	-67 to 392 (-55 to 200)	Chomerics
	Dielectric Strength, Vac/mil (kVac/mm)	200 (8)	200 (8)	200 (8)	200 (8)	200 (8)	ASTM D149
	Volume Resistivity, ohm-cm	10 ¹⁴	10 ¹⁴	10 ¹⁴	10 ¹⁴	10 ¹⁴	ASTM D257
	Dielectric Constant @ 1000 kHz	5.5	4.0	4.0	6.3	6.8	ASTM D150
Regulatory	Dissipation Factor @ 1000 kHz	0.010	0.003	0.003	0.002	0.022	Chomerics
	Flammability Rating	V-0	Not Tested	V-0	V-0	V-0	UL 94
	RoHS Compliant	Yes	Yes	Yes	Yes	Yes	Chomerics Certification
	Outgassing, % TML (% CVCM)	0.55 (0.14)	Not Tested	0.49 (0.18)	1.33 (0.34)	0.07 (0.01)	ASTM E595
	Shelf Life, months from date of manufacture	18	18	18	18	18	Chomerics
Storage Conditions, °F (°C) @ 50% Relative Humidity	50 to 90 (10 to 32)	50 to 90 (10 to 32)	50 to 90 (10 to 32)	50 to 90 (10 to 32)	50 to 90 (10 to 32)	Chomerics	

† Typical properties: these are not to be construed as specifications.
 * THERM-A-GAP T630 flow rate is measured through a 0.100" diameter orifice.

Dispensing Equipment Options	Optional Supplier	Description
Hand-Gun Pneumatic Dispensing 300 cc cartridges	Bergdahl Associates	SEMCO® Model 550
Hand-Gun Pneumatic Dispensing 180 cc (6 oz) cartridges	Bergdahl Associates	Model 250A-6 oz Sealant Gun
www.bergdahl.com		
Pneumatic Shot Size Controllers 30 cc, 180 cc and 300 cc shot size dispensing equipment	EFD	Ultra 2400 Series
		Ultra 1400 Series
		Ultra 870 Series
30 cc/55 cc Adapter Assembly	EFD	10000D5152
Dispensing Sleeve to support 6 oz (180 cc) SEMCO® tubes	EFD	5192-6
www.efd-inc.com		

SEMCO is a registered trademark of PPG Aerospace

THERM-A-GAP™ Gels Ordering Information

These materials are available in the following formats.

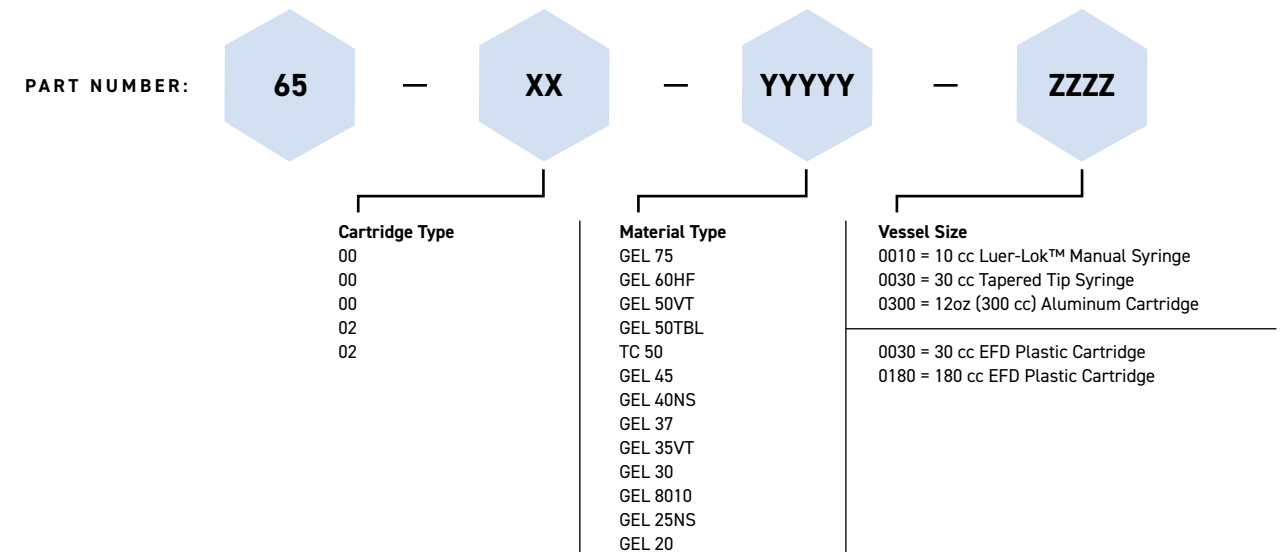

*For 1 Gallon or 5 Gallon packaging refer to the specific product data sheets for part numbers or reach out to Applications Engineering. Parker Chomerics may consider other packaging options upon request.

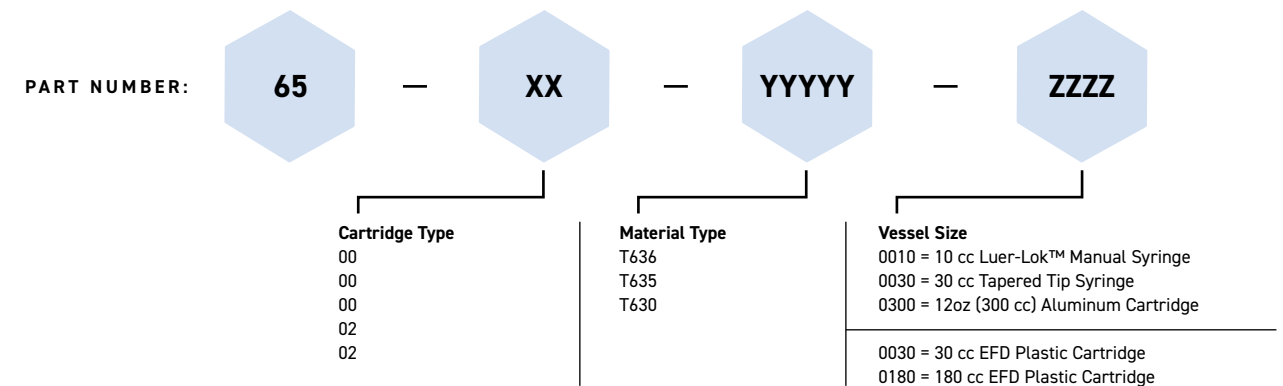

*For 1 Gallon or 5 Gallon packaging refer to the specific product data sheets for part numbers or reach out to Applications Engineering. Parker Chomerics may consider other packaging options upon request.

THERM-A-GAP™ Pads

Thermally Conductive Gap Filler Pads



THERM-A-GAP™ gap-filler sheets and pads offer excellent thermal properties and conformability at low clamping forces.

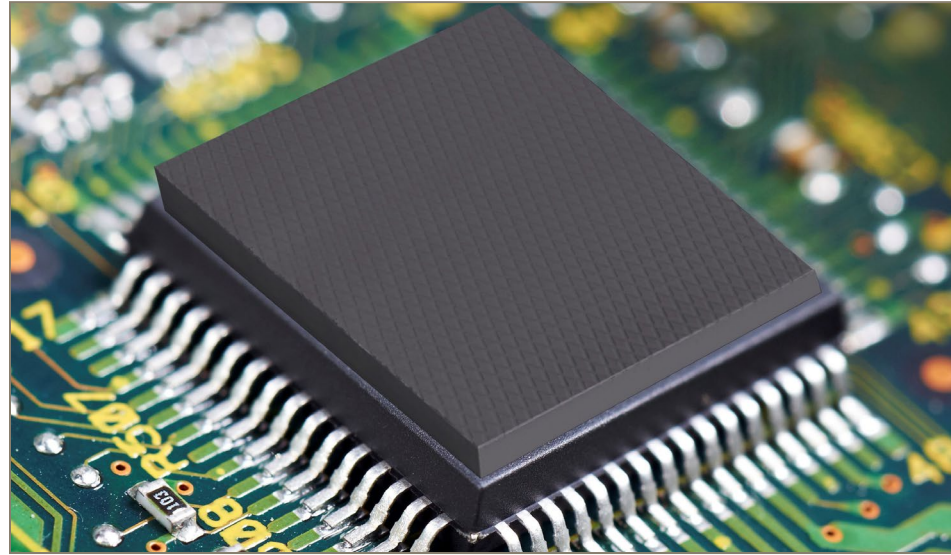

FEATURES/BENEFITS

- Ultra low deflection force
- High thermal conductivity
- High tack surface reduces contact resistance
- Various thicknesses available, finished in standard sheets
- Custom sized configurations and/or cut parts are available as individual parts or on sheets
- "A" version offers high strength acrylic PSA for ease of installation

Most products are available on aluminum foil "A" or on "clean break" glass "G" fiber carrier. As with all previous Parker Chomerics gap-fillers, the "A" versions have a high strength acrylic pressure sensitive adhesive (PSA) for ease of attachment to the cold surfaces.

TYPICAL APPLICATIONS

- Telecommunications equipment
- Consumer electronics
- Automotive electronics (ECUs)
- LEDs, lighting
- Power conversion
- Power semiconductors
- Desktop computers, laptops, servers
- Handheld devices
- Memory modules
- Vibration dampening

PERFORMANCE GUIDE

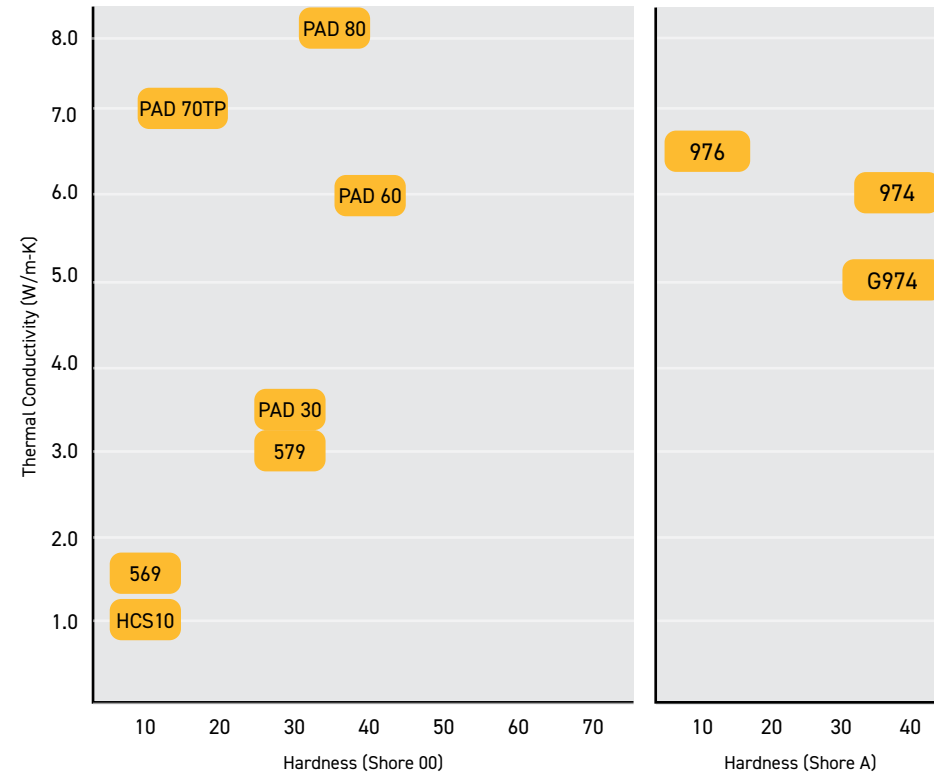

THERM-A-GAP™ Thermally Conductive Pads

	Typical Properties†	PAD 30	PAD 60	PAD 70TP	PAD 80	Test Method
Physical	Color	Blue	Green	Dark Gray	Dark Gray	Visual
	Binder	Silicone	Silicone	Silicone	Silicone	--
	Carrier Options Supported (standard): G = Woven glass carrier - no PSA A = Aluminum foil carrier - with acrylic PSA F = Woven glass carrier - centered on thickness. No pressure sensitive adhesive (PSA) option Supported (custom): PN = PEN film carrier KT = Thermally enhanced polyimide carrier Unsupported (no carrier): 579 and 580 only - no letter notation needed	PAD30G PAD30A PAD30PN PAD30KT PAD30	PAD60A PAD60	PAD70TPG PAD70TPA PAD70TPF PAD70TP	PAD80A PAD80G PAD80PN PAD80	--
	Standard Thicknesses*, in (mm)	0.020 - 0.200 (0.51 - 5.08)	0.040 - 0.200 (1.0 - 5.0)	0.030 - 0.200 (0.76 - 5.08)	0.040 - 0.200 (0.5 - 5.0)	ASTM D374
	Specific Gravity	2.9	3.3	3.3	3.4	ASTM D792
	Hardness, Shore 00	30	40	15	35	ASTM D2240
	Percent Deflection @ various pressures (0.120 in thick sample) @ 5 psi (34 kPa) @ 10 psi (69 kPa) @ 25 psi (172 kPa) @ 50 psi (345 kPa)	% Deflected 17 26 38 49**	% Deflected 8 13 24 37	% Deflected 18 42 63 †† 73 ††	% Deflected 13 25 50** 64**	ASTM C165 MOD (0.120 in "G" Type, 0.50 in dia probe, 0.025 in/min rate)§
	Operating Temperature Range, °F (°C)	-67 to 392 (-55 to 200)	-67 to 392 (-55 to 200)	-67 to 392 (-55 to 200)	-67 to 392 (-55 to 200)	Chomerics
	Thermal Conductivity, W/m-K	3.2	6.0	7.0	8.3	ASTM D5470
	Thermal Impedance, °C-in ² /W (°C-cm ² /W) @ 10 psi, @ 0.04 in (1 mm) thick, "G" version only	0.4 (2.6)	0.28 (1.8)	0.27 (1.7)	0.15 (0.97)	ASTM D5470
Thermal	Heat Capacity, J/g-K	1	1	0.72	1	ASTM E1269
	Coefficient of Thermal Expansion, ppm/K	150	150	150	150	ASTM E831
	Electrical	Dielectric Strength, Vac/mil (kVac/mm)	150 (6)	125 (8)	200 (8)	125 (5)
Volume Resistivity, ohm-cm		10 ¹³	10 ¹³	10 ¹³	10 ¹⁴	ASTM D257
Dielectric Constant @ 1,000 kHz		7.7	9.3	5.6	6.0	ASTM D150
Dissipation Factor @ 1,000 kHz		0.001	0.006	0.001	0.002	CHO-TM-TP13
Regulatory	Flammability Rating	V-0 (Tested by Chomerics)	V-0 (Tested by Chomerics)	V-0 (Tested by Chomerics)	V-0 (Tested by Chomerics)	UL 94
	RoHS Compliant	Yes	Yes	Yes	Yes	Chomerics Certification
	Outgassing, % TML (% CVCM)	0.13 (0.03)	0.05 (0.01)	0.10 (0.03)	0.11 (0.09)	ASTM E595
	Shelf Life, months from date of shipment	36	36	24	36	Chomerics
	Shelf Life, months from date of shipment - "A" aluminum foil carrier version ONLY	18	18	18	18	Chomerics
Storage Conditions, °F (°C) @ 50% Relative Humidity	50 to 90 (10 to 32)	50 to 90 (10 to 32)	50 to 90 (10 to 32)	50 to 90 (10 to 32)	Chomerics	

† Typical properties: these are not to be construed as specifications.
 †† The typical deflection of THERM-A-GAP PAD70TP is approximately 15-40%.
 * Thickness tolerance, inches(mm) is ±10% of the nominal part thickness for parts 0.100" (2.5mm) thick or less; those parts greater than 0.100" (2.5mm) thick are held to ±0.010" (0.25mm). Custom thicknesses may be available upon request.
 ** The typical deflection range is approximately 5-40%.
 *** Laminated polyester film provides low abrasion on one side as well as improved dielectric isolation.
 § THERM-A-GAP PAD 60: ASTM C165 MOD (0.50in dia. probe, 0.025 in/min rate)

THERM-A-GAP™ Thermally Conductive Pads

	Typical Properties†	HCS10	569	579	G974	974	976	Test Method
Physical	Color	Orange / Gray Carrier	Gray	Pink	Blue	Blue	Gold	Visual
	Binder	Silicone	Silicone	Silicone	Silicone	Silicone	Silicone	--
	Carrier Options Supported (standard): G = Woven glass carrier - no PSA A = Aluminum foil carrier - with acrylic PSA F = Woven glass carrier - centered on thickness No pressure sensitive adhesive (PSA) option	HCS10A HCS10G	A569 G569 569PN	A579 G579 579PN 579KT 579	Fiberglass with PSA	PSA	None*	--
	Supported (custom): PN = PEN film carrier KT = Thermally enhanced polyimide carrier							
	Unsupported (no carrier): 579 and 580 only - no letter notation needed							
	Standard Thicknesses*, in (mm)	0.010 - 0.200 (0.25 - 5.0)	0.010 - 0.200 (0.25 - 5.0)	0.010 - 0.200 (0.25 - 5.0)	0.010 - 0.100 (0.25 - 2.54)	0.020 - 0.060 (0.51 - 1.52)	0.040 - 0.200 (1.00 - 5.08)	ASTM D374
	Specific Gravity	2.0	2.2	2.9	1.4	1.4	1.3	ASTM D792
	Hardness, Shore 00	4	10	30	40	40	10	ASTM D2240
	Percent Deflection @ various pressures (0.120 in thick sample) @ 5 psi (34 kPa) @ 10 psi (69 kPa) @ 25 psi (172 kPa) @ 50 psi (345 kPa)	% Deflected 26 36 59** 73**	% Deflected 20 30 50** 65**	% Deflected 22 33 55** 68**	% Deflection 7 11 12 13	% Deflection 7 11 12 13	% Deflection 6 10 11 45**	ASTM C165 MOD (0.125 in "G" Type, 0.50 in dia probe, 0.025 in/min rate)§
	Operating Temperature Range, °F (°C)	-67 to 392 (-55 to 200)	-67 to 392 (-55 to 200)	-67 to 392 (-55 to 200)	-67 to 392 (-55 to 200)	-67 to 392 (-55 to 200)	-67 to 392 (-55 to 200)	Chomerics
Thermal	Thermal Conductivity, W/m-K	1	1.5	3	5.0	6.0	6.5	ASTM D5470
	Thermal Impedance, °C-in ² /W (°C-cm ² /W) @ 10 psi, @ 0.04 in (1 mm) thick, "G" version only	1.5 (9.7)	1.4 (9.1)	0.7 (4.5)	0.51 (3.3)	0.45 (2.9)	0.30 (1.9)	ASTM D5470
	Heat Capacity, J/g-K	1	1	1	0.9	0.9	0.9	ASTM E1269
	Coefficient of Thermal Expansion, ppm/K	N/A	250	150	100	100	100	ASTM E831
Electrical	Dielectric Strength, Vac/mil (kVac/mm)	200 (8)	200 (8)	200 (8)	200 (8)	200 (8)	200 (8)	ASTM D149
	Volume Resistivity, ohm-cm	10 ¹⁴	10 ¹⁴	10 ¹⁴	10 ¹⁴	10 ¹⁴	10 ¹⁴	ASTM D257
	Dielectric Constant @ 1,000 kHz	5.3	6.5	8.0	3.2	3.2	3.2	ASTM D150
	Dissipation Factor @ 1,000 kHz	0.013	0.013	0.010	< 0.001	< 0.001	< 0.001	CHO-TM-TP13
Regulatory	Flammability Rating	V-0	V-0	V-0	V-0	Not Tested	V-0	UL 94
	RoHS Compliant	Yes	Yes	Yes	Yes	Yes	Yes	Chomerics Certification
	Outgassing, % TML (% CVCM)	0.44 (0.13)	0.42 (0.08)	0.19 (0.06)	0.59 (0.18)	0.59 (0.18)	0.64 (0.21)	ASTM E595
	Shelf Life, months from date of shipment	36	36	36	12	12	24	Chomerics
	Shelf Life, months from date of shipment - "A" aluminum foil carrier version ONLY	18	18	18	N/A	N/A	N/A	Chomerics
Storage Conditions, °F (°C) @ 50% Relative Humidity	50 to 90 (10 to 32)	50 to 90 (10 to 32)	50 to 90 (10 to 32)	50 to 90 (10 to 32)	50 to 90 (10 to 32)	50 to 90 (10 to 32)	Chomerics	

† Typical properties: these are not to be construed as specifications.
* THERM-A-GAP 976 is only offered without a carrier, PSA not available.
** The typical deflection range for G974 and 974 is approximately 5-20%; 976 is 5-30%.

THERM-A-GAP™ Pads

Product examples showing carrier options and liners.

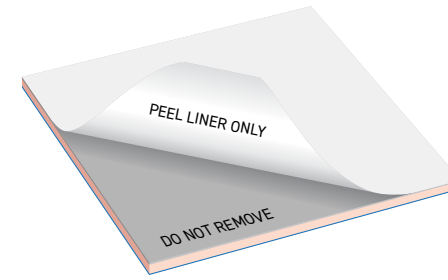

HCS10G
with gray fiberglass carrier, peelable liner

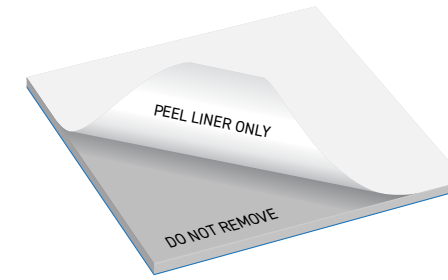

G569
with gray fiberglass carrier, peelable liner

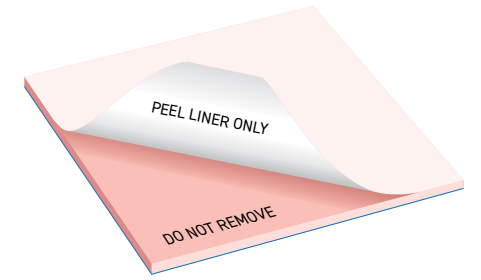

G579
with fiberglass carrier, peelable liner

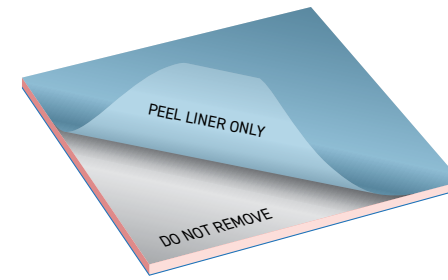

A579
with aluminum PSA carrier, peelable liner

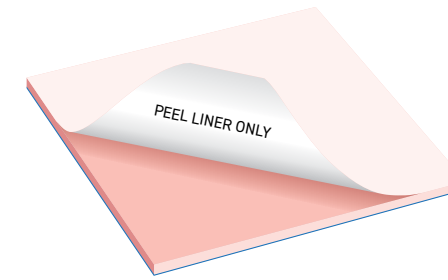

579
unsupported (no carrier), peelable liner



579KT
with thermally enhanced polyimide carrier, no liner

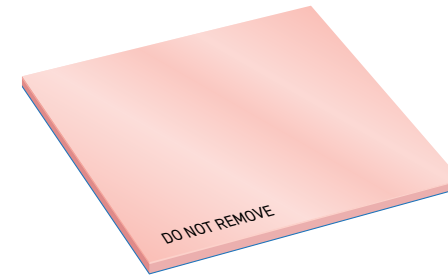

579PN
with PEN film carrier, no liner

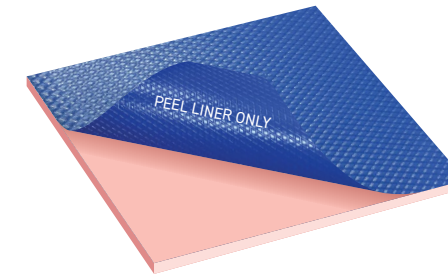

Blue base liner on all pads
remove prior to installation

Available Carriers

- G – woven fiberglass (no PSA) – this carrier option provides reinforcement and a clean break / low-tack interface surface, allowing for re-use of the pad if necessary or for prototyping.
- A – aluminum foil (with PSA) – this carrier's primary function is to allow a dedicated pressure sensitive adhesive on the gap pad
- F – Woven glass carrier - centered on thickness. No pressure sensitive adhesive (PSA) option.
- PN – PEN film (polyethyl enenapthalate) – this carrier permits the gap pad to see a shearing motion and offers a clear, cost-effective

- dielectric film with fair thermal performance.
- KT – thermally enhanced polyimide – this carrier permits the gap pad to see a shearing motion and offers an excellent dielectric film with enhanced thermal performance.
- No carrier (no letter distinction) – the no carrier or "un-reinforced" option allows the gap pad to have high-tack surfaces on both sides, allowing for the pad to be highly conformable, but it does make cutting and handling of the product more difficult.
- "A" carrier systems have a 0.005" typical thickness, transparent, blue Mylar release liner on this side. This is removed prior to use.

"G" carrier systems have a 0.003" typical thickness, opaque, white polyethylene release liner on this side. This is removed prior to use.

"PN" carrier systems have a 0.001" typical thickness, transparent, clear, polyethylene naphthalate (PEN) film on this side. DO NOT REMOVE.

"KT" carrier systems have a 0.001" typical thickness, transparent, orange, Kapton film on this side. DO NOT REMOVE.

ALL systems have on the non-carrier side, a .014 typical thickness, opaque, blue diamond embossed, poly release liner.

THERM-A-GAP™ Pads Ordering Information

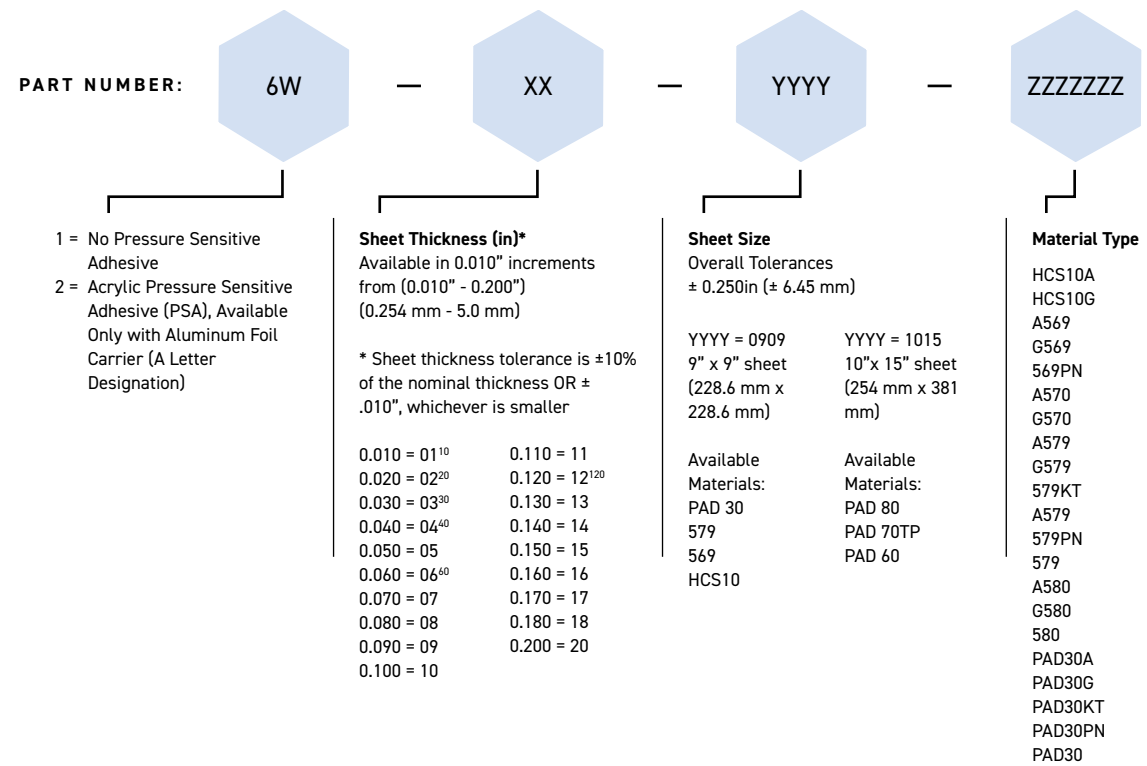

²⁰ Minimum thickness for HCS10G, 569PN, A570, G570, G579, 579PN, A580, G580, PAD30G, PAD30A, PAD30PN, PAD30KT
³⁰ Minimum thickness for PAD70TPG, PAD70TPA, PAD80A, PAD80PN
⁴⁰ Minimum thickness for PAD30, PAD60, PAD60A, PAD70TP, and PAD80, PAD80G
¹²⁰ Minimum thickness for 579, 580 (Unsupported)
⁶⁰ Minimum thickness for PAD70TPF
¹⁰ Minimum thickness for G569

Ordering Information: Custom Configurations

Sheet thickness tolerance is ± 10% of the nominal thickness OR ±0.010", whichever is smaller

Please contact Parker Chomerics for a pre-assigned part number, for custom widths, lengths and part sizes; etc

Available options include:

* Custom die-cut parts on sheets, or as individual parts

THERM-A-GAP™ Pads Ordering Information

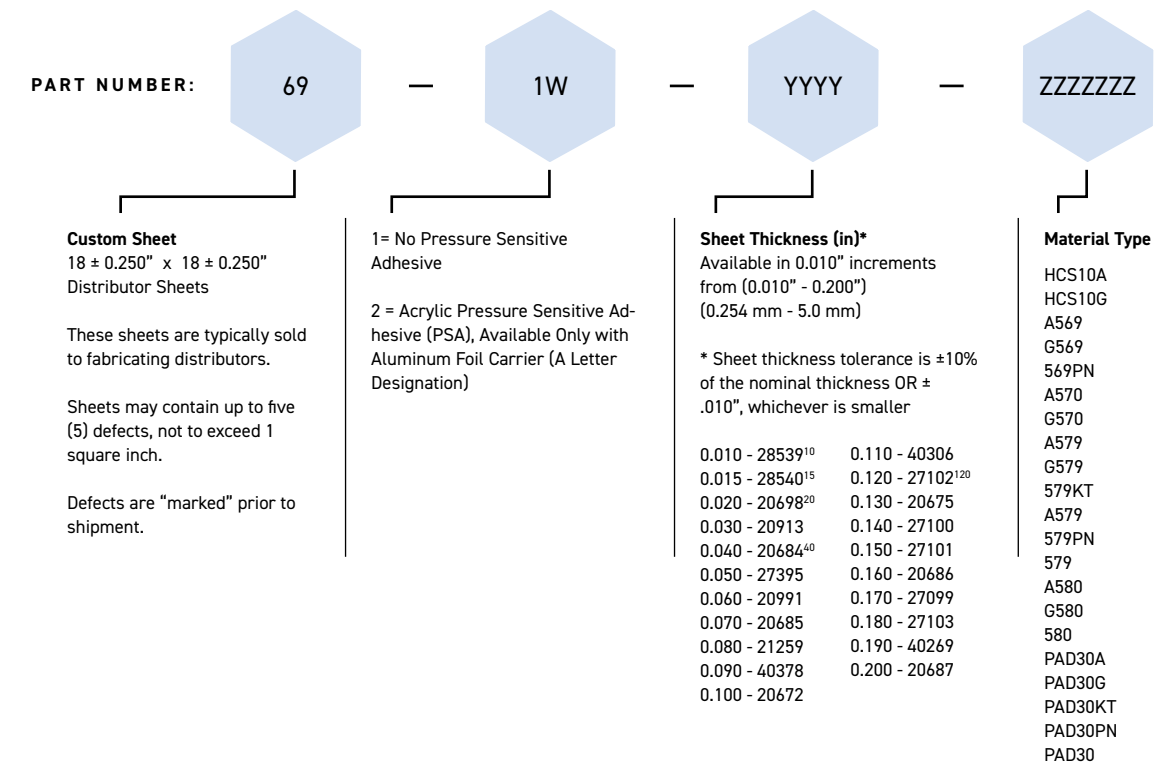

¹⁰ Minimum thickness for G569
¹⁵ Minimum thickness for G579
²⁰ Minimum thickness for HCS10G, 569PN, A570, G570, G579, 579PN, A580, G580, PAD30G, PAD30A, PAD30PN, PAD30KT
⁴⁰ Minimum thickness for PAD30
¹²⁰ Minimum thickness for PAD579, PAD580

Ordering Information: Custom Configurations

Sheet thickness tolerance is ± 10% of the nominal thickness OR ±0.010", whichever is smaller

Please contact Parker Chomerics for a pre-assigned part number, for custom widths, lengths and part sizes; etc

Available options include:

* Custom die-cut parts on sheets, or as individual parts

THERM-A-GAP™ 976 Ordering Information

9" x 12" and 20" x 25" Sheets - No Pressure Sensitive Adhesive (PSA)

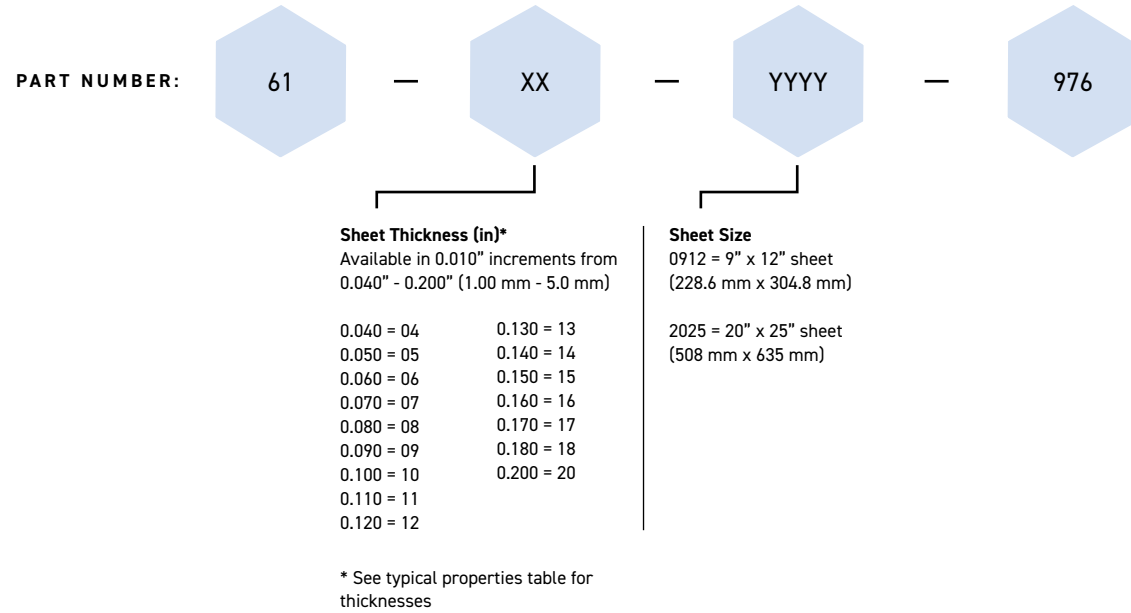

Ordering Information: Custom Configurations

Please contact Parker Chomerics for a pre-assigned part number, for custom widths, lengths and part sizes, etc.

Available options include:

- Custom die-cut parts on sheets, or as individual parts
- "A" version offered die-cut (up to 0.040") on continuous rolls (higher volumes)
- Custom molded designs and ribbed sheets

Handling Information

These products are defined by Parker Chomerics as "articles" according to the following generally recognized regulatory definition for articles:

An article is a manufactured item "formed to a specific shape or design during manufacturing," which has "end use functions" dependent upon its size and shape during end use and which has generally "no change of chemical composition during its end use."

In addition:

- There is no known or anticipated exposure to hazardous materials/substances during routine and anticipated use of the product.
- The product's shape, surface and design is more relevant than its chemical composition.

These materials are not deemed by Parker Chomerics to require an MSDS. For further questions, please contact Parker Chomerics at 781-935-4850.

THERM-A-GAP™ 974 and G974 Ordering Information

9" x 12" and 20" x 25" Sheets - Pressure Sensitive Adhesive (PSA) 1 Side

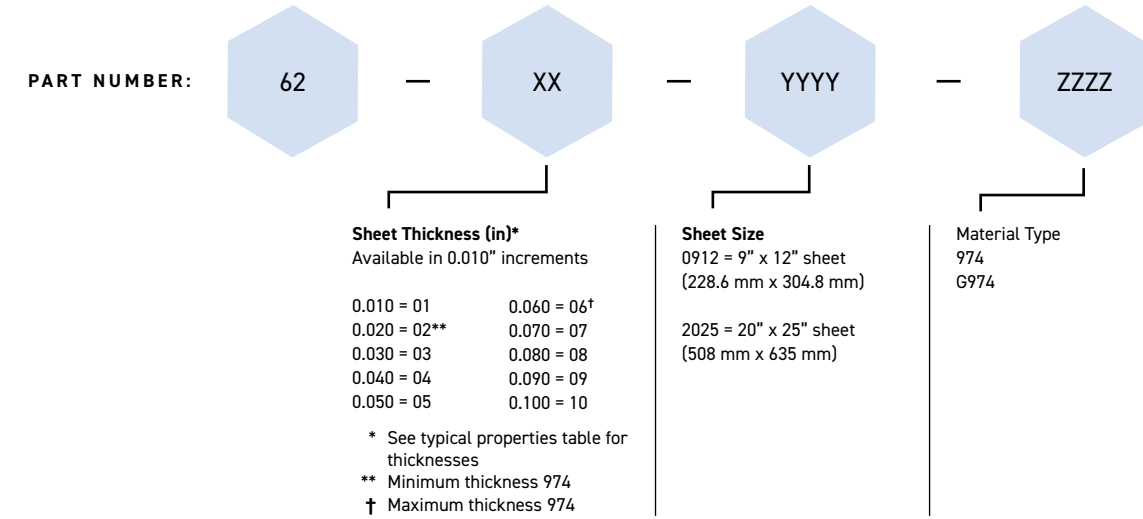

Ordering Information: Custom Configurations

Please contact Parker Chomerics for a pre-assigned part number, for custom widths, lengths and part sizes, etc.

Available options include:

- Custom die-cut parts on sheets, or as individual parts
- "A" version offered die-cut (up to 0.040") on continuous rolls (higher volumes)
- Custom molded designs and ribbed sheets

Handling Information

These products are defined by Parker Chomerics as "articles" according to the following generally recognized regulatory definition for articles:

An article is a manufactured item "formed to a specific shape or design during manufacturing," which has "end use functions" dependent upon its size and shape during end use and which has generally "no change of chemical composition during its end use."

In addition:

- There is no known or anticipated exposure to hazardous materials/substances during routine and anticipated use of the product.
- The product's shape, surface and design is more relevant than its chemical composition.

These materials are not deemed by Parker Chomerics to require an MSDS. For further questions, please contact Parker Chomerics at 781-935-4850.

THERMFLOW®

Non-Silicone, Phase-Change Thermal Interface Pads



THERMFLOW® phase-change Thermal Interface Materials (TIMs) completely fill interfacial air gaps and voids.



FEATURES/BENEFITS

- Low thermal impedance
- Proven solution – years of production use in personal computer OEM applications
- Demonstrated reliability through thermal cycling and accelerated age testing
- Can be pre-applied to heat sinks
- Protective release liner prevents contamination of material prior to final component assembly
- Tabs available for easy removal of release liner (T710, T725*, T557, T777, PC07DM)
- * T725 is only offered with a tab
- Available in custom die-cut shapes, kiss-cut on rolls

THERMFLOW phase-change materials are designed to displace entrapped air between power dissipating electronic components. Phase-change materials maximize heat sink performance and improve component reliability. THERMFLOW pads soften as they reach component operating temperatures.

Upon reaching operating temperature, THERMFLOW materials will fully change phase and attain minimum bond-line thickness (MBLT) to maximize surface wetting. This results in minimal thermal contact resistance due to a very small thermal resistance path.

At room temperature, THERMFLOW materials are solid and easy to handle. This allows them to be consistently and cleanly applied as dry pads to a heat sink or component surface. With light clamping pressure, they will readily conform to both mating surfaces.

Standard THERMFLOW products are electrically non-conductive, however

metal-to-metal contact is possible after the material undergoes phase-change, decreasing their electrical isolation properties. PC07DM-7 is the only THERMFLOW material recommended for use as a dielectric insulator.

Parker Chomerics offers two types of phase change materials—traditional thermal interface pads (PCM) and dual phase change polymer solder hybrids (PSH).

DUAL PHASE CHANGE POLYMER SOLDER HYBRID MATERIALS (PSH)

THERMFLOW brand products are also available as dual phase change polymer solder hybrid (PSH) thermal interface materials, in which case, both binder and filler change phases, to exhibit the lowest thermal impedance of the THERMFLOW family.

These thermal interface materials provide superior long term reliability performance. For optimum performance, THERMFLOW must be exposed to temperatures above

62°C during operation or by a burn-in cycle to achieve lowest thermal impedance and highest thermal performance.

TYPICAL APPLICATIONS

- Microprocessors
- Graphics processors
- Chipsets
- Memory modules
- Power modules
- Power semiconductors

APPLICATION

Material may flow when oriented vertically, especially at higher temperatures. This does not affect thermal performance, but should be considered if appearance is important.

CLEAN UP

THERMFLOW material can be removed with solvents such as toluene, methylethyl ketone (MEK), or isopropyl alcohol (IPA).

THERMFLOW Product Information

Typical Properties†	PC07DM-7	T710 with PSA	T725	T766/T766-06	T557	T558	T777	Test Method
Color	Pink	Light Gray/Off-White	Pink	Purple/Gray Foil	Gray	Gray/Gray Foil	Gray	Visual
Carrier	1 mil Polyester	2 mil Fiberglass	None - Free Film	1 mil Metal Foil	None - Free Film	1 mil Metal Foil	None - Free Film	--
Standard Thicknesses*, in (mm)	0.007 (0.178)	0.0055 (0.138)	0.005 (0.125)	0.0035 (0.088) 0.006 (0.152)	0.005 (0.125)	0.0045 (0.115)	0.0045 (0.115)	ASTM D374
Specific Gravity	1.1	1.15	1.1	2.6	2.4	3.65	1.95	ASTM D792
Phase Transition Temperature, °C	55	45	55	55	45/62***	45/62***	45/62***	ASTM D3418
Weight Loss, 125°C for 48 Hours	<0.5%	<0.5%	<0.5%	<0.5%	<0.5%	<0.5%	<0.5%	--
Thermal Impedance @ 70°C, °C-in ² /W (°C-cm ² /W)	Minimum Bond-line Thickness	Minimum Bond-line Thickness @ 50°C	2.9 mil	Minimum Bond-line Thickness	Minimum Bond-line Thickness	Minimum Bond-line Thickness	Minimum Bond-line Thickness	ASTM D5470
@ 10 psi (69 kPa)	0.35 (2.2)	0.23 (1.48)	0.11 (0.71)	0.15 (0.97)	0.02 (0.13)	0.03 (0.19)	0.02 (0.13)	
@ 25 psi (172 kPa)	0.30 (1.93)	0.16 (1.03)	0.06 (0.39)	0.09 (0.58)	0.015 (0.097)	0.013 (0.084)	0.015 (0.097)	
@ 50 psi (345 kPa)	0.28 (1.81)	0.12 (0.77)	0.04 (0.26)	0.06 (0.39)	0.008 (0.052)	0.0097 (0.06)	0.0055 (0.035)	
Minimum Bond Line Thickness (MBLT)	0.002/0.051	0.003/0.076	0.001/0.025	0.002/0.051	0.001/0.025	0.002/0.051	0.001/0.025	--
Operating Temperature Range, °F (°C)	-67 to 257 (-55 to 125)	-67 to 257 (-55 to 125)	-67 to 257 (-55 to 125)	-67 to 257 (-55 to 125)	-67 to 257 (-55 to 125)	-67 to 257 (-55 to 125)	-67 to 257 (-55 to 125)	--
Volume Resistivity, ohm-cm	10 ¹⁴	10 ¹⁴	10 ¹⁴	10 ¹⁴ Metal Foil*	Non conductive**	Non conductive**/Metal Foil*	Non conductive**	ASTM D257
Voltage Breakdown, Vac/mil (kVac/mm)	125 (5)	N/A	N/A	N/A	N/A	N/A	N/A	ASTM D149
Flammability Rating	Not Tested	Not Tested	V-0	Not Tested	Not Tested	Not Tested	Not Tested	UL 94
RoHS Compliant	Yes	Yes	Yes	Yes	Yes	Yes	Yes	Chomerics Certification
Shelf Life, months from date of shipment	12	12	12	12	12	12	12	Chomerics
Storage Conditions, °F (°C) @ 50% Relative Humidity	50 to 90 (10 to 32)	50 to 90 (10 to 32)	50 to 90 (10 to 32)	50 to 90 (10 to 32)	50 to 90 (10 to 32)	50 to 90 (10 to 32)	50 to 90 (10 to 32)	Chomerics

† Typical properties: these are not to be construed as specifications.

* Phase-change material exhibits 10¹⁴ ohm-cm volume resistivity. Metal foil is electrically conductive.

** The phase-change material is electrically non-conductive. However, as it contains dispersed solder for enhanced thermal properties, it can exhibit through-conductivity at thinner bond line thickness (approximately <2 mils). **It should not be used as an electrical insulator.**

*** The lower phase-transition temperature is for the polymer. The higher value is for the low melting alloy filler.

THERMFLOW Ordering Information

THERMFLOW materials are supplied in several standard formats (see part number guide below).

Custom die-cut shapes can also be provided on

kiss-cut rolls by Parker Chomerics' extensive network of distributor/ fabricators. To ease release liner removal, an optional tab can be added.

Standard tolerances for slitting widths and individually cut pieces are ±0.020 in (±0.51 mm).

Roll Stock - No Pressure Sensitive Adhesive (PSA)

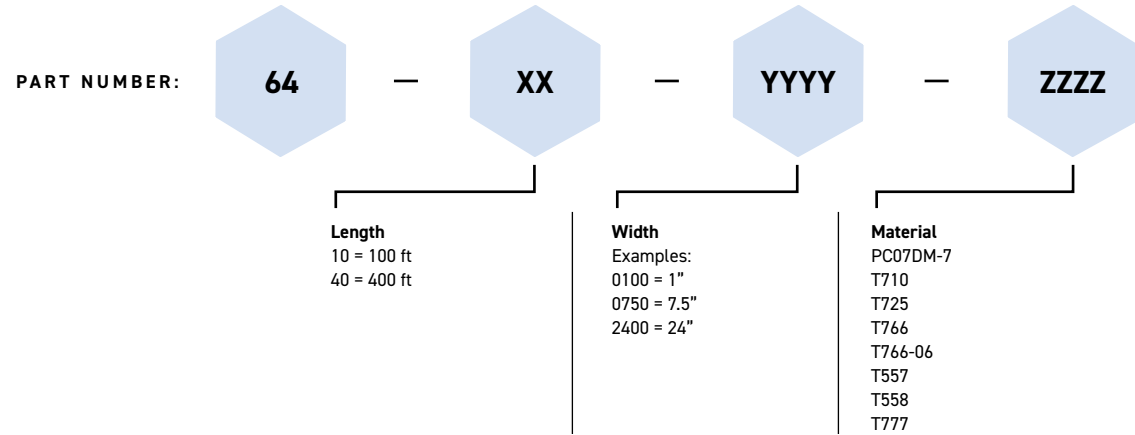

Roll Stock - With Pressure Sensitive Adhesive (PSA)

T710 only

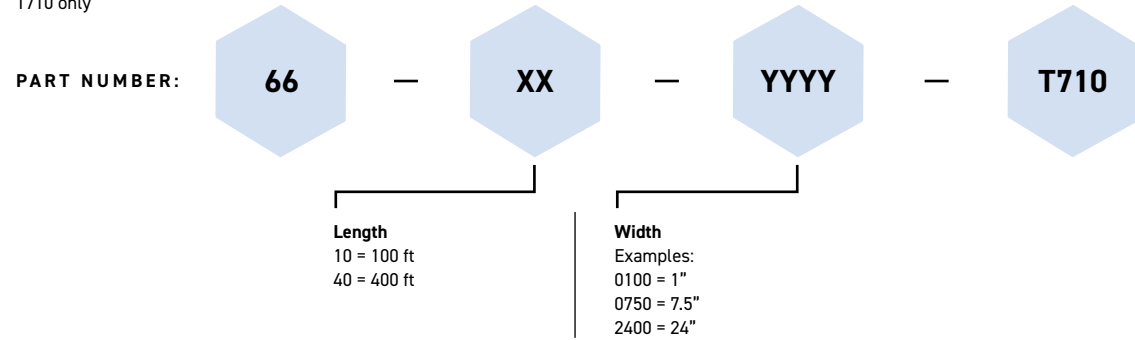

Ordering Information: Custom Configurations

Please contact Parker Chomerics for a pre-assigned part number, for custom widths, lengths and part sizes, etc.

Available options include:

- Custom kiss cut parts on sheets, or as individual parts
- Offered die-cut on continuous rolls (higher volumes)

HANDLING INFORMATION

These products are defined by Parker Chomerics as "articles" according to the following generally recognized regulatory definition for articles:

An article is a manufactured item "formed to a specific shape or design during manufacturing," which has "end use functions" dependent upon its size and shape during end use and which has generally "no change of chemical composition during its end use."

In addition:

- There is no known or anticipated exposure to hazardous materials/substances during routine and anticipated use of the product.
- The product's shape, surface, and design is more relevant than its chemical composition.

These materials are not deemed by Parker Chomerics to require an MSDS. For further questions, please contact Parker Chomerics at 781-935-4850.

THERMATTACH® Double-Sided Thermal Tapes

Thermally Conductive Attachment Tapes



THERMATTACH® double-sided thermal interface tapes provide exceptional bonding properties between electronic components and heat sinks, eliminating the need for mechanical fasteners.

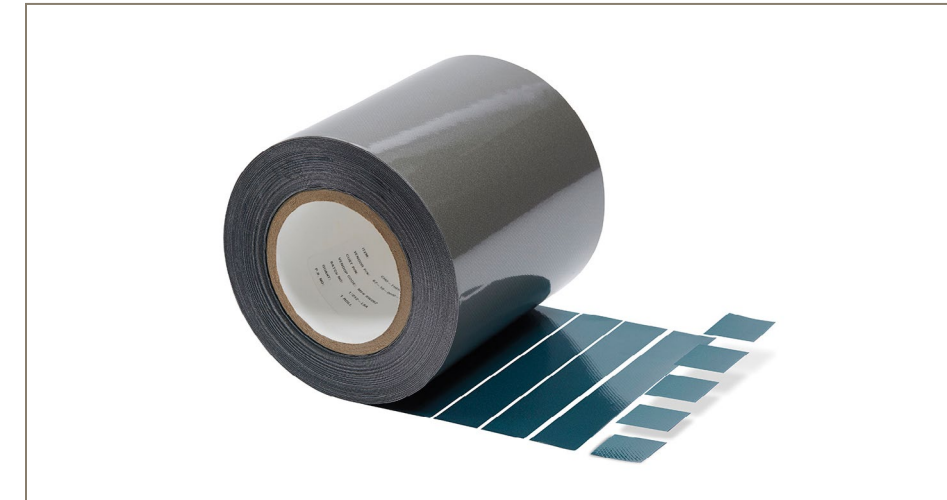

FEATURES / BENEFITS

- Offered in various forms to provide thermal, dielectric, and flame retardant properties
- Offered in custom die-cut configurations to suit a variety of applications
- Eliminates the need for mechanical attachment (i.e. screws, clips, rivets, fasteners)
- Proven reliability under various mechanical, thermal and environmental stresses
- Embossed version available
- UL recognized V-0 flammability
- No curing required, unlike epoxy or acrylic preforms or liquid systems
- Easily reworkable

TYPICAL APPLICATIONS

- Mount heat sinks to components dissipating < ~25 W
- Attach heat sinks to PC (esp. graphics) processors
- Heat sink attachment to motor control processors
- Telecommunication infrastructure components

PERFORMANCE GUIDE

Application	T412	T411	T404/T414	T405/T405-R	T418	T411
Ceramic Attachment						
Metal Attachment						
Plastic Attachment						
Dielectric Performance						
Thermal Performance						

Least suited

Best suited

THERMATTACH Product Information

Typical Properties†	T404/T414	T405/T405-R	T411	T418	T412	Test Method
Color	Beige	White	Clear/Metallic	Light Yellow	Gray	Visual
Recommended for Plastic Component Attachment	No	No	Yes	No	No	--
Embossed	Standard	Standard	No	Optional	Standard	--
Reinforcement Carrier	Filled Polyimide	Aluminum	Aluminum Mesh	Fiberglass	Aluminum Mesh	Visual
Thickness, in (mm)	0.005 (0.127)	0.006 (0.15)	0.010 (0.25)	0.010 (0.25)	0.009 (0.23)	ASTM D374
Thickness Tolerance, in (mm)	± 0.001 (0.025)	± 0.001 (0.025)	± 0.001 (0.025)	± 0.001 (0.025)	± 0.001 (0.025)	--
Adhesive CTE, ppm/°F	300	300	400	300	300	ASTM D3386
Glass Transition Temperature Range, °F (°C)	-22 (-30)	-22 (-30)	-58 (-50)	-4 (-20)	-22 (-30)	ASTM D1356
Operating Temperature Range, °F (°C)	-22 to 257 (-30 to 125)	-22 to 257 (-30 to 125)	-58 to 302 (-50 to 150)	-22 to 257 (-30 to 125)	-22 to 257 (-30 to 125)	--
Thermal Impedance °C-in ² / W (°C-cm ² /W) @ 300psi	0.6 (3.7)	0.5 (3.4)	1.0 (6.5)	1.2 (7.7)	0.30 (2.0)	ASTM D5470
Thermal Conductivity, W/m-K	0.4	0.5	0.5	0.5	1.4	ASTM D5470
Voltage Breakdown, Vac/mil (kVac/mm)	125 (5)	N/A	N/A	125 (5)	N/A	ASTM D149
Volume Resistivity, ohm-cm	3.0 X 10 ¹⁴	N/A	N/A	1.0 X 10 ¹³	1.0 X 10 ²	ASTM D257
Lap Shear Al-Al @ 25°C, psi (kPa)	100 (689)	100 (689)	40 (275)	150 (1,034)	70 (480)	ASTM D1002
90° Peel Adhesion to 0.002" aluminum foil, lbf/in (N/cm)	1.5 (2.6)	1.5 (2.6)	2.0 (3.5)	4.0 (7)	1.0 (1.8)	ASTM D1000
Die Shear Adhesion after 400 psi attachment, psi (kPa) - 2 hour sample dwell time 77°F (25°C)	130 (897)	125 (862)	110 (759)	150 (1,034)	135 (931)	Chomerics #54
Creep Adhesion, days 77°F (15°C) 302°F (125°C)	>50 >10	>50 >10	>50 >10	>50 >10	>50 >10	PSTC-7
Flammability Rating (See UL File E140244 for details)	V-0	V-0	V-0	V-0	Not Tested	UL 94
RoHS Compliant	Yes	Yes	Yes	Yes	Yes	Chomerics Certification
Shelf Life, months from shipment	12	12	12	12	12	Chomerics
Outgassing, % TML (% CVCM)	0.56 (0.02)	0.25 (0.01)	Not Tested	Not Tested	0.14 (0.00)	ASTM E595
Storage Conditions, °F (°C) @ 50% Relative Humidity	50 to 90 (10 to 32)	50 to 90 (10 to 32)	50 to 90 (10 to 32)	50 to 90 (10 to 32)	50 to 90 (10 to 32)	Chomerics

† Typical properties: these are not to be construed as specifications.

THERMATTACH Ordering Information

These attachment tapes are available on continuous rolls.

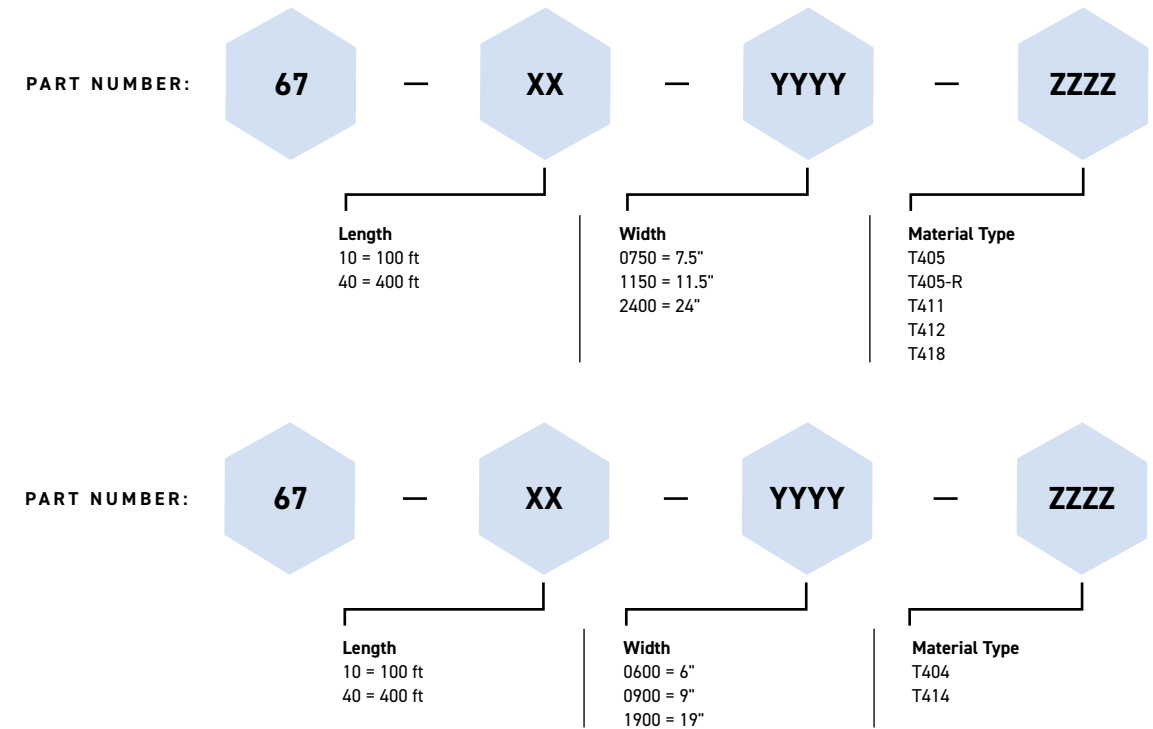

Ordering Information: Custom Configurations

Please contact Parker Chomerics for a pre-assigned part number, for custom widths, lengths and part sizes, etc.

Available options include:

- Custom kiss cut parts on sheets, or as individual parts

HANDLING INFORMATION

These products are defined by Parker Chomerics as "articles" according to the following generally recognized regulatory definition for articles:

An article is a manufactured item "formed to a specific shape or design during manufacturing," which has "end use functions" dependent upon its size and shape during end use and which has generally "no change of chemical composition during its end use."

In addition:

- There is no known or anticipated exposure to hazardous materials/substances during routine and anticipated use of the product.
- The product's shape, surface and design is more relevant than its chemical composition.

These materials are not deemed by Parker Chomerics to require an MSDS. For further questions, please contact Parker Chomerics at 781-935-4850.

THERMATTACH Application Instructions

MATERIALS NEEDED

- Clean lint-free cloth rag
- Industrial solvent
- Rubber gloves

For optimal performance, Parker Chomerics recommends interface flatness of 0.001 in/in (0.025 mm/25 mm) to 0.002 in/in (0.050 mm/25 mm) maximum.

Step 1: Ensure that bonding surfaces are free from oil, dust or any contamination that may affect bonding. Using rubber gloves, wipe surfaces with a cloth dampened with industrial solvents such as MEK, toluene, acetone or isopropyl alcohol.

Step 2: Cut tape to size* and remove a liner or remove pre-cut tape from roll.

*Note: Due to variations in heat sink surfaces, Parker Chomerics' data indicates that it sometimes is beneficial to be cut slightly smaller than the area of the heat sink. See illustration.

Step 3: Apply to center of heat sink bonding area and smooth over entire surface using moderate hand pressure / rubbing motion. A roller may be useful to help smooth the part to the surface by rolling from the center out to beyond the edges of the part. This ensures optimal contact between tape and heat sink.

Step 4: Center heat sink onto component and apply using any one of the recommended temperature/pressure options:

More pressure equals better wetting out of the adhesive to the contact surfaces. A twisting motion during assembly of the substrates will typically improve wetting.

Note that typically 70% of the ultimate adhesive bond strength is achieved with initial application, and 80-90% is reached within 15 minutes. Ultimate adhesive strength is achieved within 36 hours; however the next manufacturing step can typically occur immediately following the initial application.

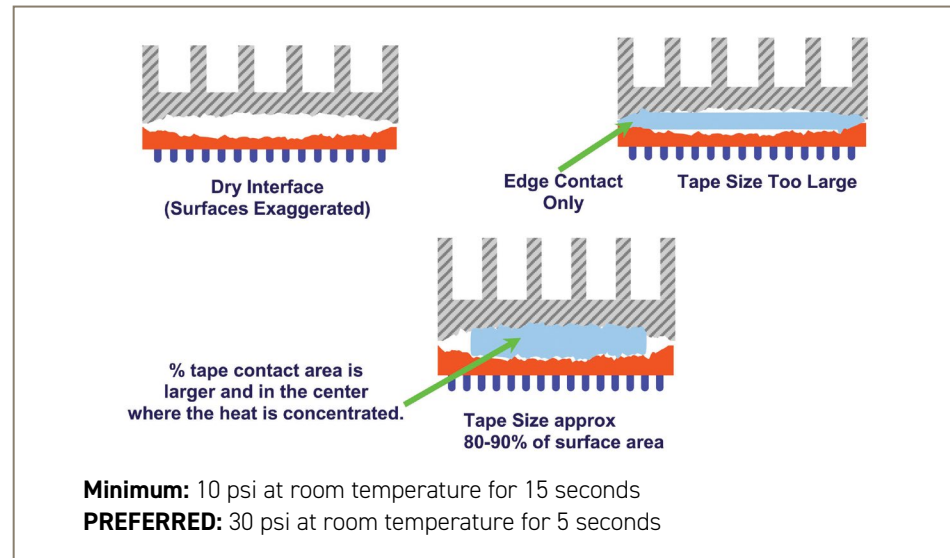

REMOVAL INSTRUCTIONS

Materials needed: Single-edged razor blade or a small, thin-bladed pocketknife; soft, thin metal spatula. Use safety precautions when handling sharp instruments and organic solvents.

Step 1: Carefully insert the blade edge into the bond line at a corner between the heat sink and the component. The penetration need not be very deep.

Step 2: Remove the blade and insert the spatula into the wedge. Slowly twist the spatula blade so that it exerts a slight upward pressure.

Step 3: As the two surfaces start to separate, move the spatula blade deeper into the bond line and continue the twisting motion and upward force.

Step 4: After the two components are separated, the tape can be removed and discarded. If adhesive remains on the component surfaces, it must be removed. Wipe with a clean rag (lint-free) dabbed with MEK, toluene, or isopropyl alcohol. Use sufficient solvent to remove all adhesive.

Step 5: Solvent cleaned components must be verified 100% free of cleaning solvent prior to reattachment of adhesive.

Thermally Conductive Attachment Tapes

Typical Properties	T418	T412	T404/T414	T405/T405-R	T411
Ceramic Attachment	●●●●●	●●●●○	●●●●○	●●●●○	●●●●○
Metal Attachment	●●●●●	●●●●○	●●●●○	●●●●○	●●●●○
Plastic Attachment	●○○○*	○○○○*	○○○○*	○○○○*	●●●●●
Dielectric Performance	●●●●○	○○○○*	●●●●●	○○○○*	○○○○*
Thermal Performance	●●○○○	●●●●●	●●●●○	●●●●○	●●○○○

* Not Recommended

THERM-A-FORM™

Cure-in-Place Potting and Underfill Materials



THERM-A-FORM™ thermally conductive silicone elastomer products are dispensable form-in-place compounds designed for heat transfer without excessive compressive force in electronics cooling applications.

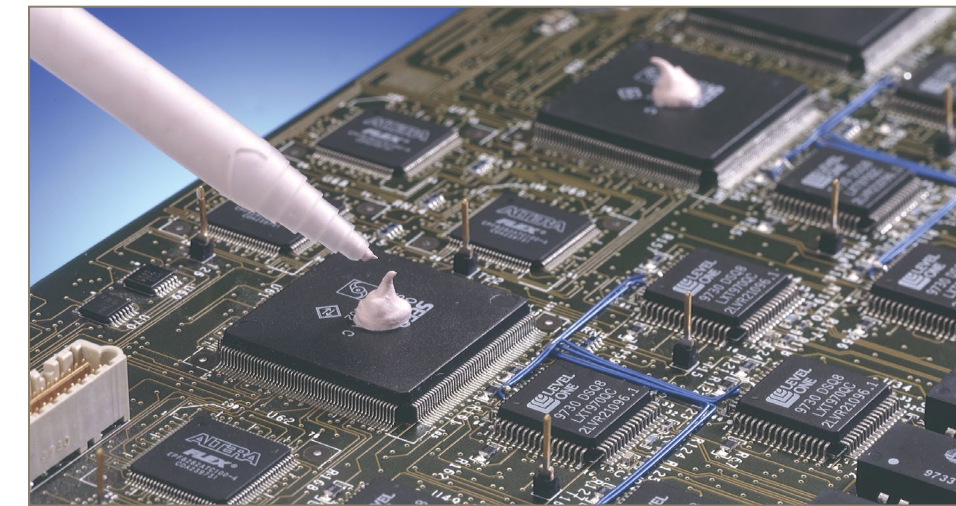

FEATURES / BENEFITS

- Cures in place once dispensed
- Dispensable form-in-place gap filling, potting, sealing and encapsulating
- Excellent blend of high thermal conductivity, flexibility and ease of use
- Conformable to irregular shapes without excessive force on components
- Ready-to-use cartridge system eliminates weighing, mixing and de-gassing steps
- Variety of kit sizes and configurations available to suit any application (handheld twin-barrel cartridges, Semco® tubes and pneumatic applicators)
- Vibration damping

PERFORMANCE GUIDE

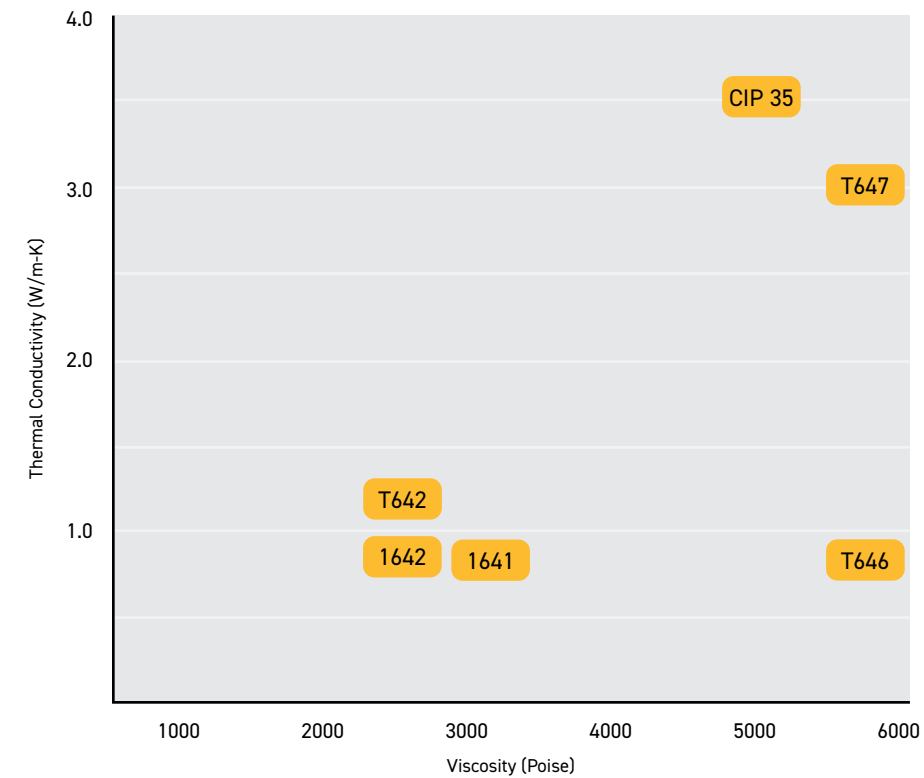

TYPICAL APPLICATIONS

- Automotive electronic control units (ECUs)
 - Engine control
 - Transmission control
 - Braking/traction control
- Power conversion equipment
- Power supplies and uninterruptible power supplies
- Power semiconductors
- MOSFET arrays with common heat sinks
- Televisions and consumer electronics

THERM-A-FORM Product Information

Typical Properties†	T646	T642	T647	CIP 35	Test Method
Color	Yellow	Blue	Gray	Green	Visual
Binder	Silicone	Silicone	Silicone	Silicone	--
Filler	Aluminum Oxide	Boron Nitride	Aluminum Oxide	Aluminum Oxide / Boron Nitride	--
Number of Components	2-part	2-part	2-part	2-part	--
Mix Ratio (by weight)	1 : 1	10 : 1	1 : 1	1 : 1	
Specific Gravity	2.45	1.50	2.8	2.87	ASTM D792
Hardness, Shore A	50	70	25	55	ASTM D2240
Viscosity, poise	> 5000	2500	> 5000	5000	ASTM D2196
Pot Life, minutes	300	60	300	100	Time to 2X Starting Viscosity at 23°C
Cure Cycles	3 min @ 150°C 60 min @ 60°C 48 hrs @ 23°C	3 min @ 150°C 30 min @ 70°C 48 hrs @ 23°C	3 min @ 150°C 60 min @ 60°C 48 hrs @ 23°C	30 min @ 150°C 180 min @ 100°C 48 hrs @ 23°C	Chomerics
Thermal Conductivity, W/m-K	0.90	1.20	3.0	3.5	ASTM D5470
Heat Capacity, J/g-K	1	1	0.9	1	ASTM E1269
Coefficient of Thermal Expansion, ppm/K	250	300	150	150	ASTM E831
Operating Temperature Range, °F (°C)	-58 to 302 (-50 to 150)	-58 to 302 (-50 to 150)	-58 to 302 (-50 to 150)	-67 to 392 (-55 to 200)	Chomerics
Dielectric Strength, Vac/mil (kVac/mm)	250 (10)	500 (20)	250 (10)	250 (10)	ASTM D149
Volume Resistivity, ohm-cm	1.0 x 10 ¹⁴	1.0 x 10 ¹³	1.0 x 10 ¹⁴	1.0 x 10 ¹⁴	ASTM D257
Dielectric Constant @ 1,000 kHz	6.5	4.0	8	8	ASTM D150
Dissipation Factor @ 1,000 kHz	0.013	0.001	0.010	0.010	Chomerics
Flammability Rating (See UL File E140244 for details)	V-0	Not Tested	V-0	V-0	UL 94
RoHS Compliant	Yes	Yes	Yes	Yes	Chomerics Certification
Outgassing, % TML (% CVCM)	0.17 (0.10)	0.32 (0.21)	Not Tested	0.22 (0.06)	ASTM E595
Shelf Life, months from date of manufacture	3	3	3	12	Chomerics
Storage Conditions, °F (°C) @ 50% Relative Humidity	50 to 90 (10 to 32)	50 to 90 (10 to 32)	50 to 90 (10 to 32)	50 to 90 (10 to 32)	Chomerics

† Typical properties: these are not to be construed as specifications.

THERM-A-FORM Product Information

Typical Properties†	1641	1642	Test Method
Color	White	Blue	Visual
Binder	Silicone	Silicone	--
Filler	Aluminum Oxide	Aluminum Oxide	--
Number of Components	1-part	2-part	--
Mix Ratio (by weight)	N/A	100 : 3	
Specific Gravity	2.1	2.3	ASTM D792
Hardness, Shore A	56	76	ASTM D2240
Viscosity, poise	3000	2500	ASTM D2196
Pot Life, minutes	30	60	Time to 2X Starting Viscosity at 23°C
Cure Cycles	48 hrs @ 23°C @ 50% RH	60 min @ 100°C 4 hrs @ 65°C 1 week @ 23°C	Chomerics
Thermal Conductivity, W/m-K	0.90	0.95	ASTM D5470
Heat Capacity, J/g-K	1	1	ASTM E1269
Coefficient of Thermal Expansion, ppm/K	150	200	ASTM E831
Operating Temperature Range, °F (°C)	-94 to 392 (-70 to 200)	-94 to 392 (-70 to 200)	Chomerics
Dielectric Strength, Vac/mil (kVac/mm)	500 (20)	500 (20)	ASTM D149
Volume Resistivity, ohm-cm	1.0 x 10 ¹³	1.0 x 10 ¹³	ASTM D257
Dielectric Constant @ 1,000 kHz	3.9	3.9	ASTM D150
Dissipation Factor @ 1,000 kHz	0.010	0.010	Chomerics
Flammability Rating	0.53 (0.15)	Not Tested	UL 94
RoHS Compliant	Yes	Yes	Chomerics Certification
Outgassing, % TML (% CVCM)	0.53 (0.15)	0.40 (0.18)	ASTM E595
Shelf Life, months from date of manufacture	6	12	Chomerics
Storage Conditions, °F (°C) @ 50% Relative Humidity	50 to 90 (10 to 32)	50 to 90 (10 to 32)	Chomerics

† Typical properties: these are not to be construed as specifications.

THERM-A-FORM Ordering Information

Mixpac™ Dispensing Systems are available from multiple sources. When contacting Mixpac equipment suppliers, reference cartridge volume (cc) and dual element cartridge A:B mix ratio. Refer to table for volume and mix ratio information.

MIXPAC is a trademark of Sylzer. SEMCO is a registered trademark of PPG Aerospace.

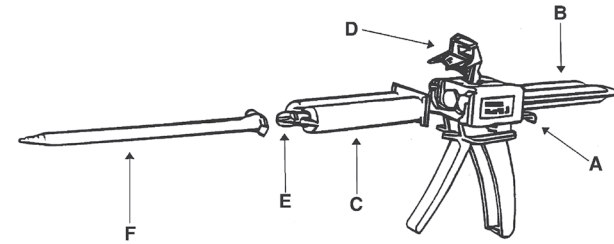

Figure 1: Typical Applicator

APPLICATION INSTRUCTIONS

35 cc and 45 cc Kits (See Figure 1)

Push safety latch (A) upward. Insert the pushrod (B) into the applicator with the pushrod gear teeth facing downward. Insert the cartridge (C) into the slots on top of the applicator. Push the retainer clamp (D) down firmly to lock the cartridge in place. Remove the cartridge cap (E) with a 1/4 turn counter-clockwise. Attach the static mixer (F) to the cartridge. (For the 10:1 cartridge, make certain that the small notch on the mixer tube face is toward the large barrel containing Part A.) Turn the mixer tube 1/4 turn clockwise to lock it in place. Cut the tip of the mixing nozzle to obtain the desired bead size, or attach a needle with the Luer adapter. After use, discard the static mixer and replace the cap on any remaining material.

Product	Part Number	Volume (mass)	Description
1641	65-00-1641-0000	2.5 fluid ounces (70 grams)	1-Component foil squeeze tube
	65-01-1641-0000	12 fluid ounces (340 grams)	1-Component SEMCO® cartridge
1642	65-00-1642-0000	277 grams (approx 120 cc)	1-Pint plastic jar A / vial of B
	65-00-T642-0035	35 cc (53 grams)	10:1 Dual element cartridge
T642	65-00-T642-0250	250 cc (372 grams)	
	65-00-T644-0045	45 cc (68 grams)	1:1 Dual element cartridge
T644	65-00-T644-0200	200 cc (300 grams)	
	T646	65-00-T646-0045	45 cc (115 grams)
65-00-T646-0200		200 cc (507 grams)	
T647	65-00-T647-0045	45 cc (125 grams)	1:1 Dual element cartridge
	65-00-T647-0200	200 cc (560 grams)	
CIP 35	65-00-CIP35-0045	45 cc (128 grams)	(2) 600 cc SEMCO® cartridges
	65-00-CIP35-0200	200 cc (570 grams)	
	65-00-CIP35-0400	400 cc (1140 grams)	
	65-00-CIP35-1200	1200 cc (3440 grams)	
	65-1P-CIP35-5600	5600 cc (16 kg)	
	65-5P-CIP35-10452	10,452 cc (30 kg)	(2) 5-Gallon pails, each pail has 15 kg

CHO-THERM®

Thermally Conductive Electrical Insulator Pads



CHO-THERM® Thermal Insulator Pads are designed for use as alternatives to greased mica insulators between discrete power devices and heat sinks. These products are offered as dry pads, or with an optional pressure-sensitive acrylic adhesive (PSA) layer for ease of installation.

FEATURES / BENEFITS

- Excellent mechanical strength and puncture resistance
- Available with & without acrylic PSA
- UL recognized V-0 flammability rating

COMMERCIAL GRADE

- Good thermal properties
- Good to excellent dielectric strength
- Available on continuous rolls for easy peel and stick application

HIGH POWER

- Excellent thermal properties
- High dielectric strength
- 100% inspected for dielectric properties on every sheet
- Extremely low NASA outgassing
- Proven through decades of use in demanding military and aerospace applications

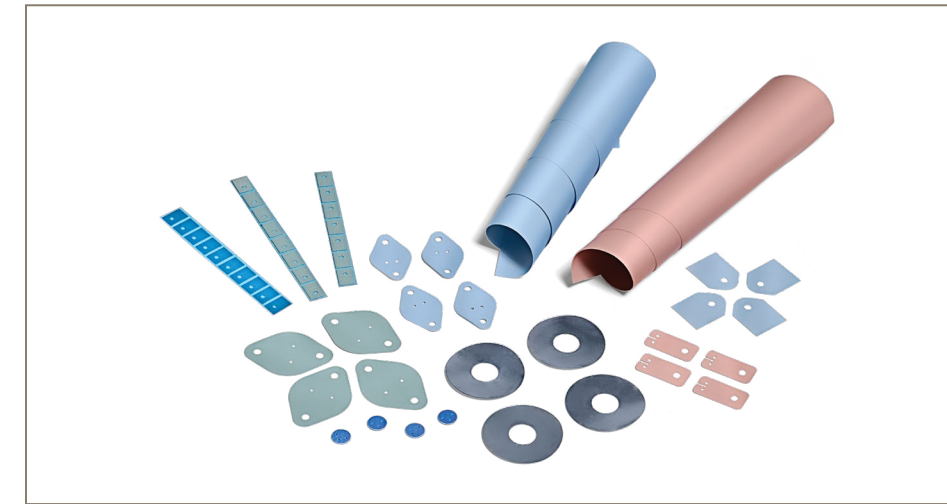

TYPICAL APPLICATIONS

- Power conversion equipment
- Power supplies & UPS
- Power semiconductors
- Automotive electronics
- Motor and engine controllers
- Televisions and consumer electronics

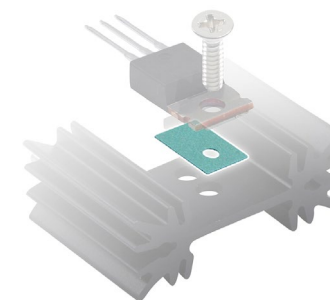

PERFORMANCE GUIDE

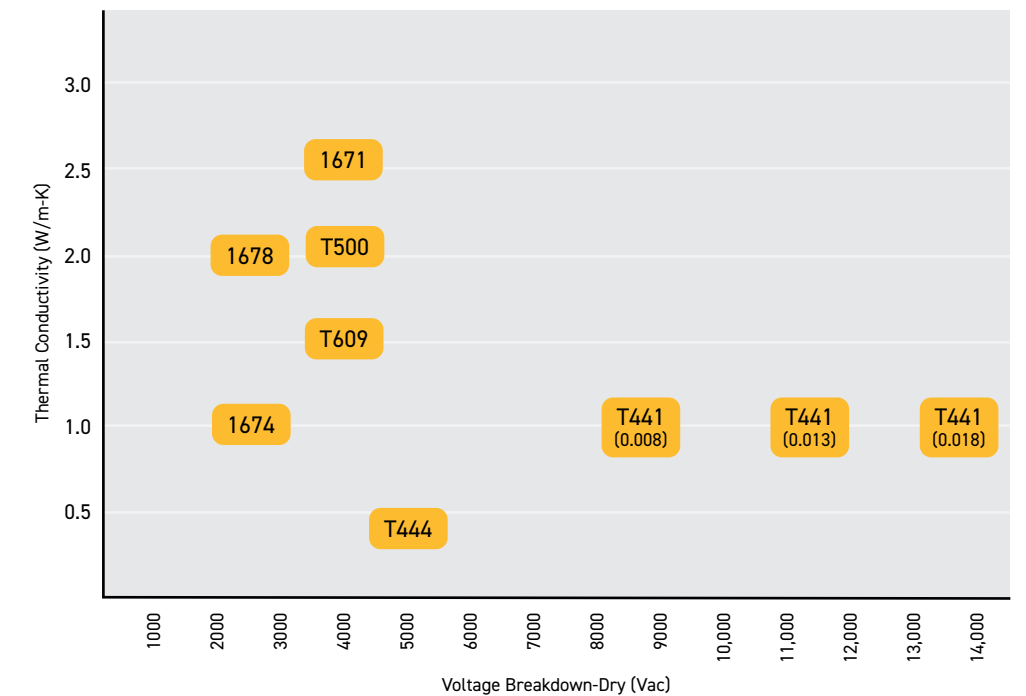

CHO-THERM Product Information

Typical Properties†		T444	1674	T441			T609	Test Method
Physical	Color	Beige	Blue	Pink			Gray	Visual
	Material	Non-Silicone	Silicone	Silicone			Silicone	--
	Reinforcement Carrier	Filled Polyimide with PSA	Fiberglass	Fiberglass			Fiberglass	Visual
	Thickness, in (mm)	0.003 (0.08)	0.010 (0.25)	0.008 (0.20)	0.013 (0.33)	0.018 (0.46)	0.010 (0.25)	ASTM D374
	Thickness Tolerance, in (mm)	0.0005 (± 0.013)	0.001 (± 0.025)	0.001 (± 0.025)	0.001 (± 0.025)	0.001 (± 0.025)	0.001 (± 0.025)	--
Thermal	Operating Temperature Range, °F (°C)	-40 to 392 (-40 to 200)	-40 to 392 (-40 to 200)	-40 to 392 (-40 to 200)	-40 to 392 (-40 to 200)	-40 to 392 (-40 to 200)	-40 to 392 (-40 to 200)	Chomerics
	Thermal Impedance, °C-in ² /W (°C-cm ² /W) @ 300 psi*	0.37 (2.4)	0.41 (2.6)	0.41 (2.6)	0.56 (3.6)	0.64 (4.1)	0.33 (2.1)	ASTM D5470
	Thermal Conductivity, W/m-K	0.4	1.0	1.1	1.1	1.1	1.5	ASTM D5470
	Heat Capacity, J/g-°C	1	1	1	1	1	1	ASTM E1269
	Coefficient of Thermal Expansion, ppm/°C	400	300	300	300	300	150	ASTM E831
Electrical	Voltage Breakdown Dry, Vac/mil (kVac/mm)	5,000 (200)	2,500 (100)	8,700 (350)	11,400 (450)	13,800 (550)	4,000 (150)	ASTM D149
	Voltage Breakdown Wet, Vac/mil (kVac/mm)	Not Tested	Not Tested	8,100	10,500	12,900	Not Tested	ASTM D149
	Volume Resistivity Dry, ohm-cm	10 ¹⁴	10 ¹⁴	10 ¹⁴	10 ¹⁴	10 ¹⁴	10 ¹⁴	ASTM D257
	Volume Resistivity Wet, ohm-cm	Not Tested	Not Tested	10 ¹⁴	10 ¹⁴	10 ¹⁴	Not Tested	ASTM D257
Mechanical	Tensile Strength, psi (Mpa)	3,000 (20.7)	1,500 (10.3)	2,800 (19.3)	2,500 (17.3)	2,000 (13.8)	3,900 (26.9)	ASTM D412
	Tear Strength, lb/in (kN/m)	150 (26.3)	100 (17.5)	135 (23.6)	110 (19.3)	70 (12.25)	300 (52.5)	ASTM D642
	Elongation, %	N/A	2	40	40	40	30	ASTM D412
	Hardness, Shore A	90	85	80	80	80	70	ASTM D2240
	Specific Gravity	1.70	2.45	2.45	2.45	2.45	2.10	ASTM D792
Regulatory	Flammability Rating (See UL File E140244)	V-0	Not Tested	V-0	V-0	V-0	V-0	UL 94
	RoHS Compliant	Yes	Yes	Yes	Yes	Yes	Yes	Chomerics Certification
	Outgassing, % TML (% CVCM)	0.53 (0.00)	0.45 (0.20)	Not Tested	Not Tested	Not Tested	Not Tested	ASTM E595
	Shelf Life, months from shipment, dry pad (with PSA)	(12)	Indefinite (12)	Indefinite (12)	Indefinite (12)	Indefinite (12)	Indefinite (6)	Chomerics
	Storage Conditions, °F (°C) @ 50% Relative Humidity	50 to 90 (10 to 32)	50 to 90 (10 to 32)	50 to 90 (10 to 32)	50 to 90 (10 to 32)	50 to 90 (10 to 32)	50 to 90 (10 to 32)	Chomerics

† Typical properties: these are not to be construed as specifications.
* Tested without PSA. PSA typically adds 0.05 °C-in²/W (0.30 °C-cm²/W)

CHO-THERM Product Information

Typical Properties†		1678	T500	1671	Test Method
Physical	Color	Pink	Green	White	Visual
	Material	Silicone	Silicone	Silicone	--
	Reinforcement Carrier	Fiberglass	Fiberglass	Fiberglass	--
	Thickness, in (mm)	0.010 (0.25)	0.010 (0.25)	0.015 (0.38)*	ASTM D374
	Thickness Tolerance, in (mm)	± 0.002 (0.050)	± 0.002 (0.050)	± 0.002 (0.050)	--
Thermal	Operating Temperature Range, °F (°C)	-76 to 392 (-60 to 200)	-76 to 392 (-60 to 200)	-76 to 392 (-60 to 200)	Chomerics
	Thermal Impedance, °C-in ² /W (°C-cm ² /W) @ 300 psi**	0.20 (1.26)	0.19 (1.2)	0.23 (1.48)	ASTM D5470
	Thermal Conductivity, W/m-K	2.0	2.1	2.6	ASTM D5470
	Heat Capacity, J/g-°C	1	1	1	ASTM E1269
	Coefficient of Thermal Expansion, ppm/K	250	250	250	ASTM E831
Electrical	Voltage Breakdown Dry, Vac/mil (kVac/mm)	2,500 (100)	4,000 (150)	4,000 (150)	ASTM D149
	Volume Resistivity Dry, ohm-cm	10 ¹⁶	10 ¹⁶	10 ¹⁴	ASTM D149
	Dielectric Constant at 1,000 kHz	3.6	3.5	3.6	ASTM D150
	Dissipation Factor at 1,000 kHz	0.007	0.003	0.007	CHO-TM-TP13
Mechanical	Tensile Strength, psi (Mpa)	3,000 (20.7)	3,000 (20.7)	3,000 (20.7)	ASTM D412
	Tear Strength, lb/in (kN/m)	200 (35)	400 (70)	400 (70)	ASTM D642
	Elongation, %	20	20	15	ASTM D412
	Hardness, Shore A	80	80	80	ASTM D2240
	Specific Gravity	1.55	1.60	1.55	ASTM D792
Regulatory	Flammability Rating (See UL File E140244)	V-0	V-0	HB	UL 94
	RoHS Compliant	Yes	Yes	Yes	Chomerics Certification
	Outgassing, % TML (% CVCM)	0.55 (0.12)	0.40 (0.10)	0.76 (0.07)	ASTM E595
	Shelf Life, months from shipment, dry pad (with PSA)	Indefinite (18)	Indefinite (18)	Indefinite (18)	Chomerics
Storage Conditions, °F (°C) @ 50% Relative Humidity	50 to 90 (10 to 32)	50 to 90 (10 to 32)	50 to 90 (10 to 32)	Chomerics	

† Typical properties: these are not to be construed as specifications.
* 1671 material is available in custom thicknesses.
** Tested without PSA. PSA typically adds 0.05 °C-in²/W (0.30 °C-cm²/W).

CHO-THERM Ordering Information

- Die-cut parts on continuous rolls
- Slit rolls starting at 0.5" wide; maximum width is material specific

Standard Die-Cut Parts

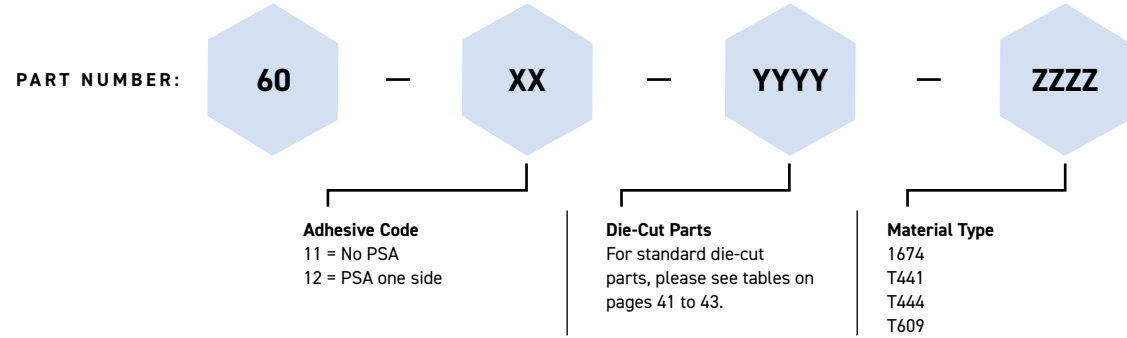

Roll Stock

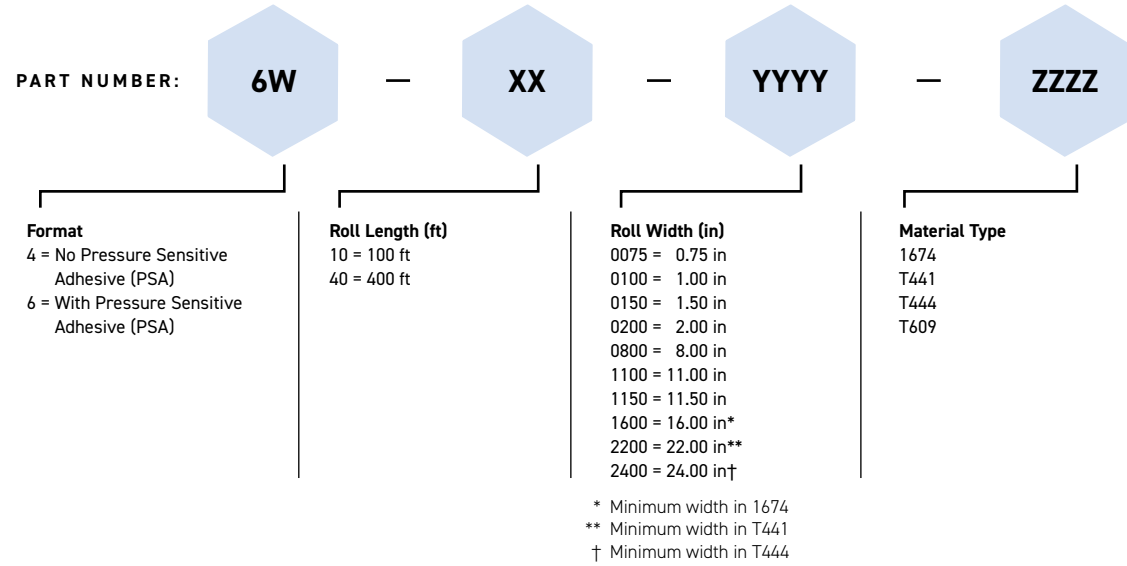

Ordering Information: Custom Configurations

Please contact Parker Chomerics for a pre-assigned part number, for custom widths, lengths and part sizes, etc.

Available options include:

- Custom die-cut parts on sheets, or as individual parts

CHO-THERM Ordering Information

Standard Die-Cut Parts

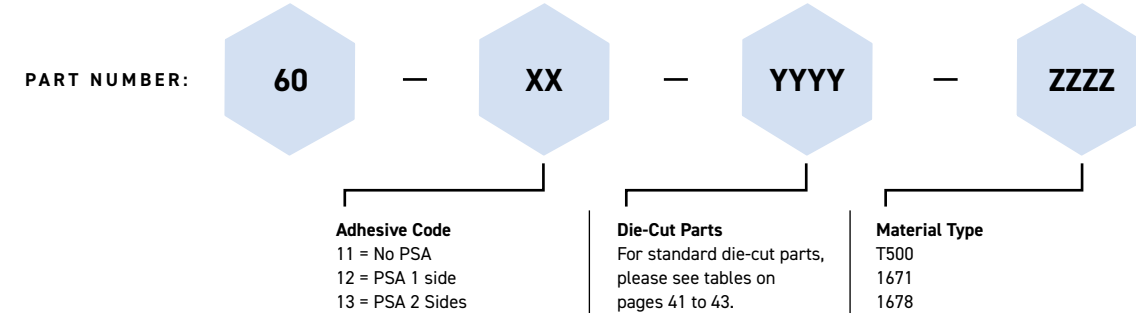

8" x 8" or 8" x 10" Sheets

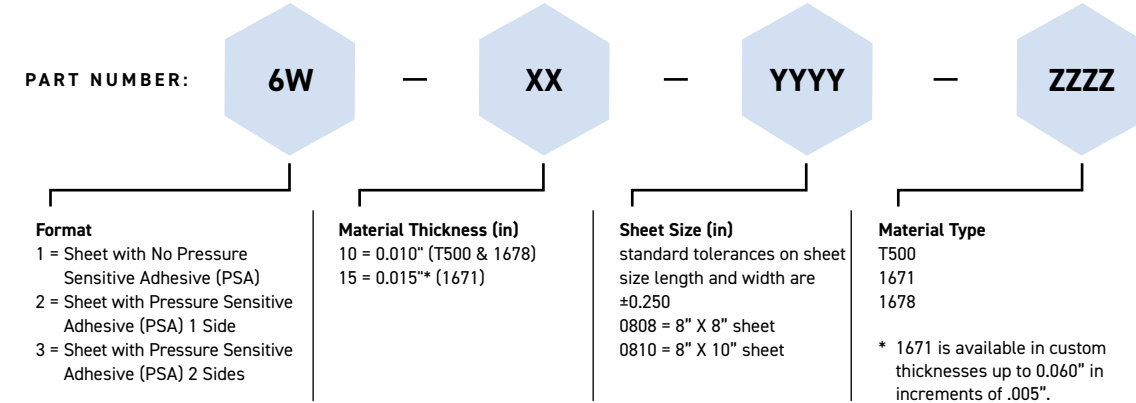

Ordering Information: Custom Configurations

Please contact Parker Chomerics for a pre-assigned part number, for custom widths, lengths and part sizes, etc.

Available options include:

- Custom die-cut parts on sheets, or as individual parts

HANDLING INFORMATION

These products are defined by Parker Chomerics as "articles" according to the following generally recognized regulatory definition for articles:

An article is a manufactured item "formed to a specific shape or design during manufacturing," which has "end use functions" dependent upon its size and shape during end use and which has generally "no change of chemical composition during its end use."

In addition:

- There is no known or anticipated exposure to hazardous materials/substances during routine and anticipated use of the product.
- The product's shape, surface and design is more relevant than its chemical composition.

These materials are not deemed by Parker Chomerics to require an MSDS. For further questions, please contact Parker Chomerics at 781-935-4850.

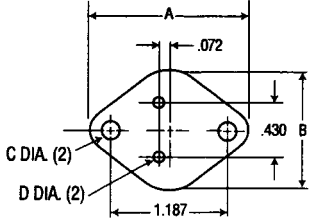
Recommended Screw Torque	Configuration	Dimensions (inches)							Ordering Number
		A	B	C	D	E	F	G	
#4-40 5 in-lb #6-32 6 in-lb	TO-3 	1.563	1.050	0.140	0.080				60-XX-D065-ZZZZ
		1.563	1.050	0.140	0.140				60-XX-4305-ZZZZ
		1.593	1.100	0.156	0.070				60-XX-4511-ZZZZ
		1.650	1.065	0.140	0.046				60-XX-D370-ZZZZ
		1.650	1.140	0.122	0.062				60-XX-D371-ZZZZ
		1.650	1.140	0.140	0.093				60-XX-6875-ZZZZ
		1.650	1.140	0.165	0.062				60-XX-D372-ZZZZ
		1.650	1.140	0.140	0.046				60-XX-D373-ZZZZ
		1.650	1.140	0.165	-				60-XX-D374-ZZZZ
		1.700	1.187	0.156	0.062				60-XX-4996-ZZZZ
		1.730	1.250	0.156	0.062				60-XX-5442-ZZZZ
		1.780	1.250	0.140	0.093				60-XX-D375-ZZZZ
		1.780	1.250	0.165	0.094				60-XX-D376-ZZZZ
		1.780	1.250	0.140	0.046				60-XX-D377-ZZZZ
		2.07	1.56	0.122	0.062				60-XX-D378-ZZZZ

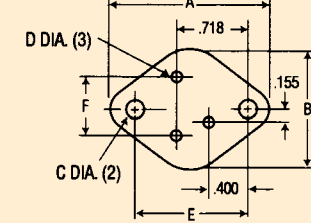
#4-40 5 in-lb #6-32 6 in-lb	3 LEAD TO-3 	1.65	1.140	0.140	0.093	1.187	0.430		60-XX-D379-ZZZZ
--------------------------------	---------------------------------------------------------------------------------------------------------	------	-------	-------	-------	-------	-------	--	-----------------

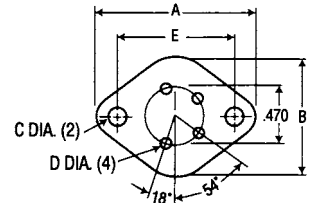
#4-40 5 in-lb #6-32 6 in-lb	4 LEAD TO-3 	1.560	1.050	0.158	0.080	1.170			60-XX-D380-ZZZZ
		1.563	1.050	0.156	0.063	1.187			60-XX-D381-ZZZZ

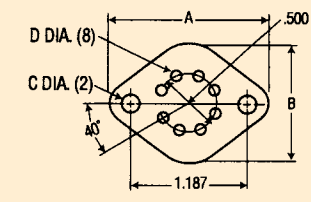
#4-40 5 in-lb #6-32 6 in-lb	8 LEAD TO-3 	1.650	1.187	0.156	0.062				60-XX-D382-ZZZZ
--------------------------------	-----------------------------------------------------------------------------------------------------------	-------	-------	-------	-------	--	--	--	-----------------

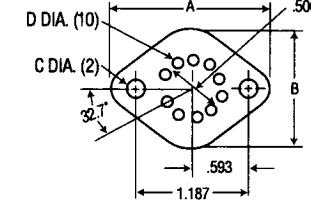
#4-40 5 in-lb #6-32 6 in-lb	10 LEAD TO-3 	1.650	1.140	0.165	0.040				60-XX-D383-ZZZZ
--------------------------------	------------------------------------------------------------------------------------------------------------	-------	-------	-------	-------	--	--	--	-----------------

1 in-lb = 1.152 kg-cm

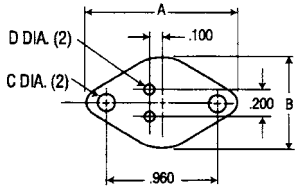
Recommended Screw Torque	Configuration	Dimensions (inches)							Ordering Number
		A	B	C	D	E	F	G	
#4-40 3 in-lb #6-32 4 in-lb	TO-66 	1.250	0.700	0.140	0.062				60-XX-4353-ZZZZ
		1.312	0.762	0.140	0.062				60-XX-5527-ZZZZ
		1.375	0.825	0.140	0.062				60-XX-4997-ZZZZ
		1.440	1.000	0.140	0.075				60-XX-D384-ZZZZ

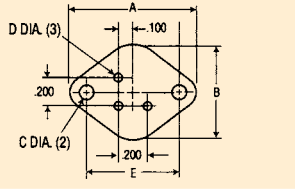
#4-40 3 in-lb #6-32 4 in-lb	3 LEAD TO-66 	1.275	0.750	0.156	0.100	0.960			60-XX-D385-ZZZZ
--------------------------------	------------------------------------------------------------------------------------------------------------	-------	-------	-------	-------	-------	--	--	-----------------

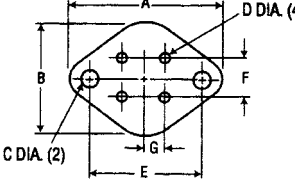
#4-40 3 in-lb #6-32 4 in-lb	4 LEAD TO-66 	1.312	0.762	0.140	0.062	0.960	0.200	0.100	60-XX-D386-ZZZZ
--------------------------------	------------------------------------------------------------------------------------------------------------	-------	-------	-------	-------	-------	-------	-------	-----------------

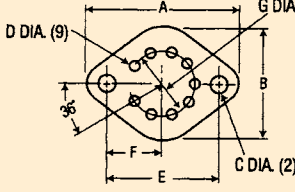
#4-40 3 in-lb #6-32 4 in-lb	9 LEAD TO-66 	1.440	1.000	0.140	0.055	0.960	0.480	0.325	60-XX-D387-ZZZZ
--------------------------------	-------------------------------------------------------------------------------------------------------------	-------	-------	-------	-------	-------	-------	-------	-----------------

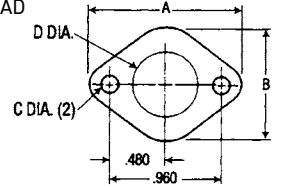
#4-40 3 in-lb #6-32 4 in-lb	MULTI LEAD TO-66 	1.35	0.800	0.140	0.400				60-XX-D388-ZZZZ
--------------------------------	------------------------------------------------------------------------------------------------------------------	------	-------	-------	-------	--	--	--	-----------------

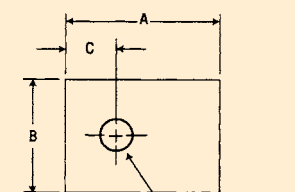
#4-40 2 in-lb	TO-220 	0.437	0.312	0.140	0.093				60-XX-D389-ZZZZ
		0.437	0.312	0.140	0.122				60-XX-D390-ZZZZ
		0.500	0.385	0.170	0.120				60-XX-D391-ZZZZ
		0.610	0.560	0.245	0.125				60-XX-D392-ZZZZ
		0.687	0.562	0.218	0.125				60-XX-5791-ZZZZ
		0.710	0.500	0.160	0.141				60-XX-8302-ZZZZ
		0.750	0.410	0.225	0.156				60-XX-D393-ZZZZ
		0.750	0.500	---	---				60-XX-8531-ZZZZ
		0.750	0.500	0.187	0.147				60-XX-6956-ZZZZ
		0.750	0.500	0.187	0.125				60-XX-D394-ZZZZ
		0.750	0.600	0.240	0.150				60-XX-D395-ZZZZ
		0.750	0.600	0.240	0.115				60-XX-D396-ZZZZ
		0.855	0.562	0.218	0.125				60-XX-D397-ZZZZ
		0.855	0.630	0.230	0.093				60-XX-D398-ZZZZ
		0.860	0.740	0.200	0.160				60-XX-D399-ZZZZ
1.125	0.625	0.200	0.145				60-XX-D400-ZZZZ		
1.410	0.810	0.355	0.147				60-XX-D401-ZZZZ		

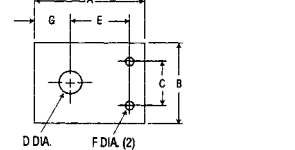
#4-40 2 in-lb		0.910	0.500	0.200	0.125	0.580	0.046	0.265	60-XX-D402-ZZZZ
		0.983	0.750	0.432	0.156	0.665	0.101	0.217	60-XX-D403-ZZZZ

Recommended Screw Torque	Configuration	Dimensions (inches)							Ordering Number		
		A	B	C	D	E	F	G			
#4-40 2 in-lb	TYPE II TO-220 	1.00	0.500	0.200	0.141	0.626				60-XX-4969-ZZZZ	
#10-32 2 in-lb #25-28 7 in-lb	DIODE WASHERS DO-4 	0.360	0.260							60-XX-D404-ZZZZ	
		0.510	0.140							60-XX-D405-ZZZZ	
		0.510	0.200							60-XX-D406-ZZZZ	
		0.512	0.161							60-XX-D407-ZZZZ	
		0.625	0.195							60-XX-4659-ZZZZ	
	DO-5		0.750	0.125							60-XX-D408-ZZZZ
			0.800	0.190							60-XX-D409-ZZZZ
			0.800	0.260							60-XX-D410-ZZZZ
			0.812	0.115							60-XX-D411-ZZZZ
			0.812	0.145							60-XX-D412-ZZZZ
			0.875	0.313							60-XX-D413-ZZZZ
			1.000	0.140							60-XX-D414-ZZZZ
			1.000	0.255							60-XX-4661-ZZZZ
			1.180	0.515							60-XX-D415-ZZZZ
1.250	0.380							60-XX-D416-ZZZZ			
1.500	0.200							60-XX-D417-ZZZZ			
1.500	0.500							60-XX-D418-ZZZZ			
	TO-36 	1.063	0.690	0.200						60-XX-4306-ZZZZ	
	TO-5 and TO-18 3 holes 	0.250	0.100	0.036						60-XX-D419-ZZZZ	
		0.360	0.200	0.040						60-XX-4374-ZZZZ	
		0.390	0.200	0.040						60-XX-D420-ZZZZ	
	4 holes		0.250	0.100	0.036						60-XX-D421-ZZZZ
			0.360	0.200	0.040						60-XX-D422-ZZZZ
			0.390	0.200	0.040						60-XX-D423-ZZZZ
#4-40 2 in-lb	RECTIFIER 	1.000	1.000	0.187						60-XX-D424-ZZZZ	
		1.125	1.125	0.140						60-XX-D425-ZZZZ	
		1.250	1.250	0.200						60-XX-D426-ZZZZ	
#4-40 2 in-lb	TIP PACKAGE 	0.865	0.650	0.650	0.140					60-XX-5792-ZZZZ	
		0.865	0.650	0.650	0.140					60-XX-D427-ZZZZ	
		0.984	0.787	---	---						60-XX-D428-ZZZZ
		0.984	0.787	0.780	0.142						60-XX-D429-ZZZZ
		1.260	0.787	0.984	0.142						60-XX-D430-ZZZZ

1 in-lb = 1.152 kg-cm

T-WING® HEAT SPREADERS

Thin Heat Spreaders

Parker Chomerics' family of thin heat spreaders provides a low-cost, effective means of cooling IC devices in restricted spaces where conventional heat sinks are inappropriate.

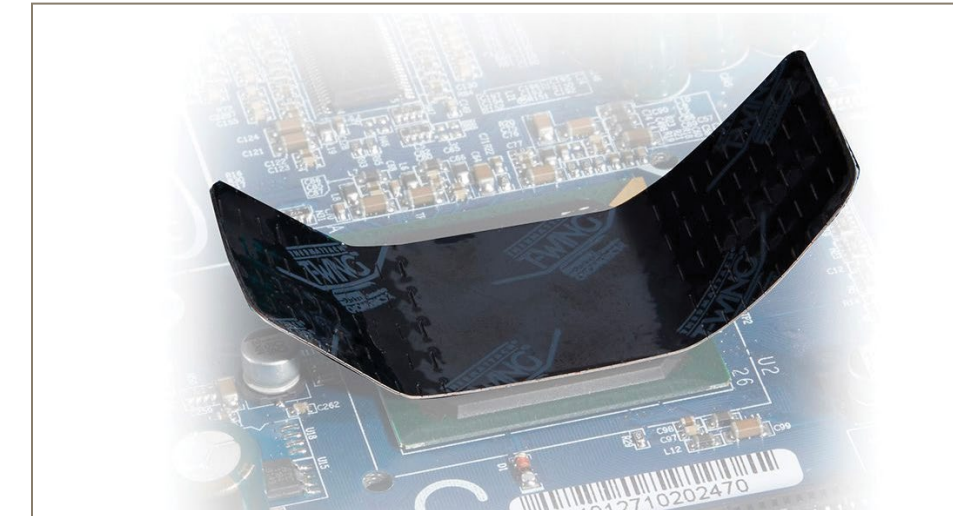

FEATURES/BENEFITS

- Component junction temperature reduction of 10 to 20°C is common
- Easily added to existing designs to lower component temperatures and improve reliability
- Custom shapes available for complex designs

TYPICAL APPLICATIONS

- Microprocessors
- Memory modules
- Laptop PCs and other high density, handheld portable electronics
- High speed disk drives

DESIGN DETAILS

- Low profile (0.33 mm/0.013 in) allows use in limited space environments
- Easy peel and stick adhesion to all surfaces, including packages with residual silicone mold release
- Offers low cost cooling for many package types
- Low application force (<5 psi/ 0.03 MPa) minimizes risk of damage to component
- Available in a range of standard sizes
- Pliable nature allows conformance to concave or otherwise non-flat surfaces for optimal thermal and mechanical performance
- Light weight (0.039 oz/in²)
- Standard parts are scored for easy forming and alignment
- Easy removal for device replacement
- Available die-cut on continuous rolls

TESTING SUMMARY

Summaries of test procedures used for T-WING heat spreaders are described below. Thermal performance, adhesion strength and visual inspection were used as pass/fail criteria.

Apparatus

Anatek® Thermal Analyzer: The ATA was used to measure R_{j-a} before and after environmental stressing. PQFP: 196 lead, plastic PQFPs known to contain silicone mold release were evaluated. T-WING Heat Spreader: 1 in x 4 in T-WING parts were applied to the PQFP packages with a 5 psi (0.03 MPa) mounting pressure.

T-WING® Heat Spreaders Product Information

THERMAL PERFORMANCE

Various sizes of T-WING heat spreaders were applied to a 196 lead PQFP using less than 5 psi (0.03 MPa) bonding pressure. Within 30 minutes of application, the test boards were mounted in an Analysis Tech® thermal analyzer. The devices were heated to equilibrium (45 to 60 minutes) with approximately 3 watt load on 3 x 3 in (7.6 x 7.6 cm) test boards.

Two test environments were used: restricted convection, achieved with a 1 x 5 x 6 in (2.5 x 12.7 x 15.2 cm) plexiglass box; and 100 LFM (30 m/min) air flow. Results were obtained using thermocouples for Tc (centered on case) and Rj-a.

Environmental Stressing

Control: Specimens were maintained for 1000 hours at standard laboratory conditions, 23°C, 35-60% RH.

Heat Aging: Test specimens were placed in a forced convection hot air oven maintained at 150°C ±5°C for 1000 hours. Test specimens were then removed and tested.

**Elevated Temperature/
High Humidity:**

Specimens were placed in a humidity chamber maintained at 85°C ± 2°C and 90%-0 +10% RH for 1000 hours.

Temperature Cycling: Specimens were subjected to 500 cycles from -50°C to +150°C in a Tenney Temperature Cycling Oven.

Temperature Shock: Specimens were subjected to 100 temperature shocks by immersion into -50° and +150°C liquids. Temperatures were monitored with thermocouples.

Evaluation Procedure

Visual: All test specimens were examined for de-bonding, delamination or other signs that the tape was failing after environmental stress.

Thermal Performance: T-WING was applied to the PQFP with 5 psi mounting pressure. After a one hour dwell, the Rj-a of each specimen was measured at 100 LFM and under restricted convection conditions. The Rj-a was again measured after environmental stressing.

90° Peel Strength: A T-WING heat spreader was applied to each PQFP with 5 psi mounting pressure. The specimens were subjected to environmental stress and then tested for 90° peel strength at room temperature.

Results

Visual: There was no visual evidence of T-WING adhesion failure to the PQFP after the environmental stresses.

Thermal Performance: The before and after thermal resistances are given in Table 4. The data shows that the thermal resistances were essentially unchanged by the exposures.

90° Peel Strength: The results of the peel strength tests are given above. The data shows that the average peel strength actually increases with high temperature/humidity and temperature shock, while remaining unchanged with heat aging and decreasing slightly with temperature cycling.

APPLICATION INSTRUCTIONS

Materials needed: Clean cotton cloth or rag, industrial solvent, rubber gloves.

Step 1: For best results, clean the top surface of the component using a lint-free cotton cloth.

Step 2: Wipe the bonding surface of the component with an industrial solvent, such as MEK, acetone or isopropyl alcohol. In the case of a plastic package, select a cleaner that will not chemically attack the plastic substrate. Do not touch the cleaned surface during any part of the assembly process. If the surface has been contaminated, repeat Steps 1 and 2.

Step 3: Remove the clear release liner from the T-WING part, exposing the pressure-sensitive adhesive (PSA). Avoid touching exposed adhesive with fingers.

Step 4: For best bond strength and contact area, center the exposed PSA onto the component. Press and smooth the entire T-WING bonding area with firm finger pressure of about 5 psi, for 5 seconds.

Note: Bond strength will increase as a function of time as the adhesive continues to wet out the bonding surface. Increasing any of the application variables (pressure, temperature and time) can improve bonding results.

T-WING® Heat Spreaders Product Information

	Typical Properties†	T-WING	Test Method
Physical	Color	Black	Visual
	Total Thicknesses, in (mm)	0.013 (0.33)	ASTM D374
	PSA Type	Silicone based	--
	PSA Thickness, in (mm)	0.002 (0.05)	Visual
	Insulator Type	Black polyester	--
	Insulator Layer Thickness, in (mm)	0.001 (0.025)	--
	Weight, oz/in²	0.039	--
Electrical	Thermal Conductor	Copper	--
	Maximum Operating Temperature, °F (°C)	257 (125)	--
	Thermal Conductor Thickness, in (mm)	0.007 (0.178)	--
Regulatory	Dielectric Strength, Vac/mil (kVac/mm)	5,000 (200) for each dielectric layer	ASTM D149
	Volume Resistivity, ohm-cm	N/A	ASTM D149
	Flammability Rating (See UL File E140244)	V-0	UL 94
	RoHS Compliant	Yes	Chomerics Certification
	Shelf Life, months from date of manufacture	12	Chomerics
	Storage Conditions, °F (°C) @ 50% Relative Humidity	50 to 90 (10 to 32)	Chomerics

† Typical properties: these are not to be construed as specifications.

Typical Properties

Typical Thermal Properties† (Performed on surface of 196 lead 3 Watt PQFP package)			Standard Part Size in (mm)					
Environment*	Properties	Without T-WING	0.5 x 2 (12.7 x 50.8)	0.5 x 3 (12.7 x 76.2)	0.75 x 3 (19.1 x 76.2)	1 x 3 (25.4 x 76.2)	1 x 4 (25.4 x 101.6)	1.5 x 4 (38.1 x 101.6)
Restricted Convection**	Thermal Resistance Rj-a, °C/W	26	25	23	23	22	20	19
	Case Temperature, °C	92	82	78	76	72	70	68
100 LFM***	Thermal Resistance Rj-a, °C/W	18	16	14	14	14	13	12
	Case Temperature, °C	68	57	52	49	46	44	44

† Typical properties: these are not to be construed as specifications.

* Measured values do not account for heat losses through bottom of case and leads. Ambient temperature range from 21°C to 24°C.

** Restricted convection in a simulated notebook computer environment - a 1 x 5 x 6 in (2.54 x 12.7 x 15.2 cm) plexiglass box.

*** T-WING long axis perpendicular to air flow direction in wind tunnel.

Notes

Rj-a = thermal resistance from junction to ambient

LFM = airflow rate (linear feet per minute)

T-WING® Heat Spreaders Product Information

Test	Procedure	Result	Test Method
Lap Shear - Room Temperature	apply/60 min. R.T. dwell/R.T. pull	960 oz/in ² (414 kPa)	ASTM D1000
Lap Shear - Elevated Temperature	apply/60 min. R.T. dwell/100°C pull	53 oz/in ² (23 kPa)	ASTM D1000
90° Peel - Room Temperature	apply/1 min. R.T. dwell/R.T. pull	40 oz/in (441 g/cm)	ASTM B571/D2861
90° Peel - Elevated Temperature	apply/60 min. R.T. dwell/100°C pull	20 oz/in (220 g/cm)	ASTM B571/D2861
Creep Adhesion, days	275°F (135°C), 7 oz/in ² (3 kPa), on aluminum	>80 days, no failure	PSTC-7

Environmental Stress Thermal Performance

Environment	Before	After
Heat Aging		
Rj-a, °C/W Restricted Convection	20.3	20.6
Rj-a, °C/W 100 LFM	12.7	13.1
High Temperature/Humidity		
Rj-a, °C/W Restricted Convection	21.4	21.4
Rj-a, °C/W 100 LFM	14.1	14
Temperature Cycling		
Rj-a, °C/W Restricted Convection	21.4	21.7
Rj-a, °C/W 100 LFM	14.1	13.9

Note: Tested with a 1" x 4" (25.4 x 101.6 mm) T-WING.

Environmental Stress Adhesive Performance

Environment	90° Peel Strength	
	oz/in	gm/cm
Control	36	393
Heat Aging	36	393
High Temperature/Humidity	46	514
Temperature Shock	38	424
Temperature Cycling	30	335

Note: Average of three samples tested per ASTM B571/D2861.

T-WING Heat Spreaders Ordering Information

Standard Parts: Refer to table below for part numbers and sizes. T-WING heat spreaders are available in standard packages of 100 parts/pkg.

Custom Parts: Custom configured T-WING parts are also available. Contact Parker Chomerics' Applications Engineering Department for details.

Available in standard sizes 1,000 parts per plastic tray. Also available die-cut on continuous rolls.

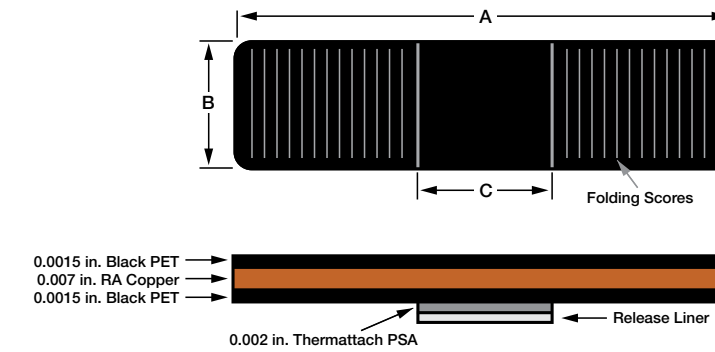
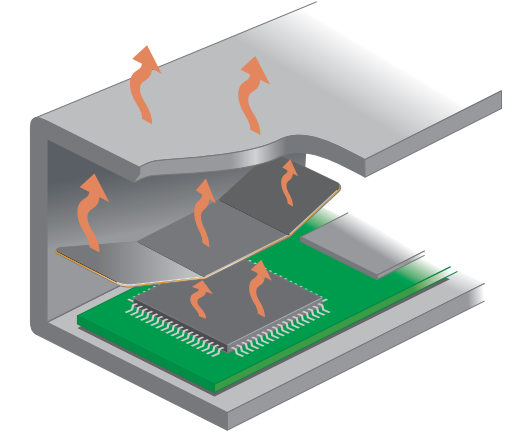

Part Numbers	Size (inches/mm)		
	A: Length, inches (mm)	B: Width, inches (mm)	C: Adhesive Width, inches (mm)
60-12-20264-TW10	2.0 (50.8)	0.50 (12.7)	0.50 (12.7)
60-12-20265-TW10	3.0 (76.2)	0.50 (12.7)	0.50 (12.7)
60-12-20266-TW10	3.0 (76.2)	0.75 (19.1)	0.75 (19.1)
60-12-20267-TW10	3.0 (76.2)	1.00 (25.4)	1.00 (25.4)
60-12-20268-TW10	4.0 (101.6)	1.00 (25.4)	1.00 (25.4)
60-12-20269-TW10	4.0 (101.6)	1.50 (38.1)	1.50 (38.1)

THERMAL GREASES



Parker Chomerics thermal greases offer a range of performance covering the simplest to the most demanding thermal requirements. These materials are screened, stenciled or dispensed and require virtually no compressive force to conform under typical assembly pressures.

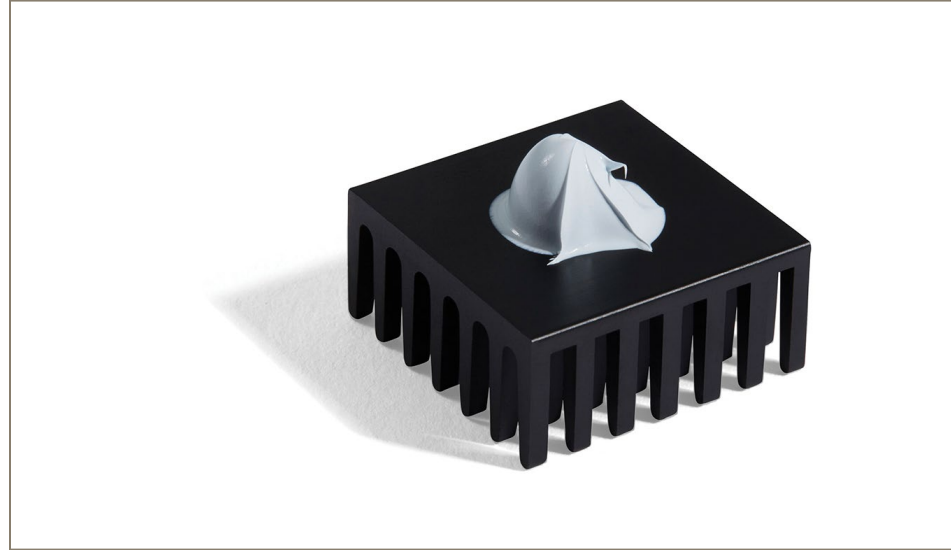

FEATURES/BENEFITS

- Silicone based materials conduct heat between a hot component and a heat sink or enclosure
- Fills interface variable tolerances in electronics assemblies and heat sink applications
- Dispensable, highly conformable materials require no cure cycle, mixing or refrigeration
- Thermally stable and require virtually no compressive force to deform under typical assembly pressures
- Supports high power applications requiring material with minimum bond line thickness and high conductivity
- Ideal for rework and field repair situations

TYPICAL APPLICATIONS

- Mobile, desktop, server CPUs
- Engine and transmission control modules
- Memory modules
- Power conversion equipment
- Power supplies and UPS
- Power semiconductors

PERFORMANCE GUIDE

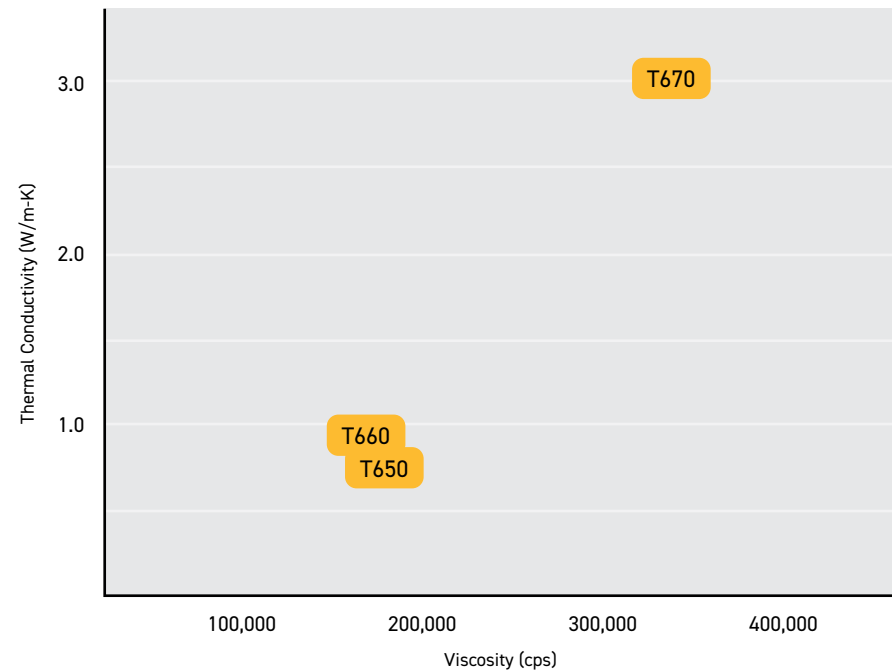

Thermal Greases Product Information

	Typical Properties†	T650	T660	T670	Test Method
Physical	Color	Pale Blue	Light Gray	White	Visual
	Specific Gravity	2.3	2.4	2.6	ASTM D792
	Viscosity, cps	190,000	170,000	350,000	--
	Operating Temperature Range, °F (°C)	-58 to 392 (-50 to 200)	-58 to 392 (-50 to 200)	-58 to 392 (-50 to 200)	--
	Phase Transition Temperature, °F (°C)	N/A	144 (62)	N/A	ASTM D3418
Thermal	Weight Loss % @ 150°C, 48 Hours	0.21	0.17	<0.2	Thermogravimetric Analysis
	Thermal Conductivity, W/m-K	0.8	0.9	3.0	ASTM D5470
	Thermal Impedance, °C-in ² /W (°C-cm ² /W) @ 100 psi	0.02 (0.13) @ 50°C 0.02 (0.13) @ 65°C	0.02 (0.13) @ 50°C 0.009 (0.06) @ 65°C	0.01 (0.07) @ 50°C 0.01 (0.07) @ 65°C	ASTM D5470
	Heat Capacity, J/g-K	1	1	1	ASTM E1269
	Minimum Bond Line Thickness (MBLT) Inches (mm)				
Electrical	Volume Resistivity, ohm-cm	10 ¹⁴	N/A	10 ¹⁴	ASTM D257
	Voltage Breakdown, Vac/mil (kVac/mm)	150* (6)	N/A*	150* (6)	ASTM D149
Regulatory	Flammability Rating	Not Tested	Not Tested	Not Tested	UL 94
	RoHS Compliant	Yes	Yes	Yes	Chomerics Certification
	Outgassing, % TML	0.21	0.17	<0.2	ASTM E595
	Shelf Life, months from date of manufacture**	24	24	24	Chomerics
	Storage Conditions, °F (°C) @ 50% Relative Humidity	50 to 90 (10 to 32)	50 to 90 (10 to 32)	50 to 90 (10 to 32)	Chomerics

† Typical properties: these are not to be construed as specifications.
* Not recommended for dielectric applications.
** Material may settle during storage, remixing may be required.

MATERIAL APPLICATION

T650

Material is supplied in various syringe or bulk packaging (see ordering information) for dispensing onto components or heat sinks. Excess material can be wiped with a clean cloth and suitable solvent.

T660

Packaging the same as T650. For optimum performance, the processor should be allowed to reach temperatures greater than 65°C (149°F). This causes the solder fillers to melt and conform to the mating surfaces, obtaining a minimum bondline thickness at the interface. This process only needs to occur one time to achieve optimum thermal performance of the grease.

T670

T670 high performance thermal grease is supplied in easy access metal cans or pails. Mix with a spatula and remove the desired amount onto the component or stencil screen. Stencil desired pad part size onto heat sink for immediate assembly or shipping.

Thermal Greases Ordering Information

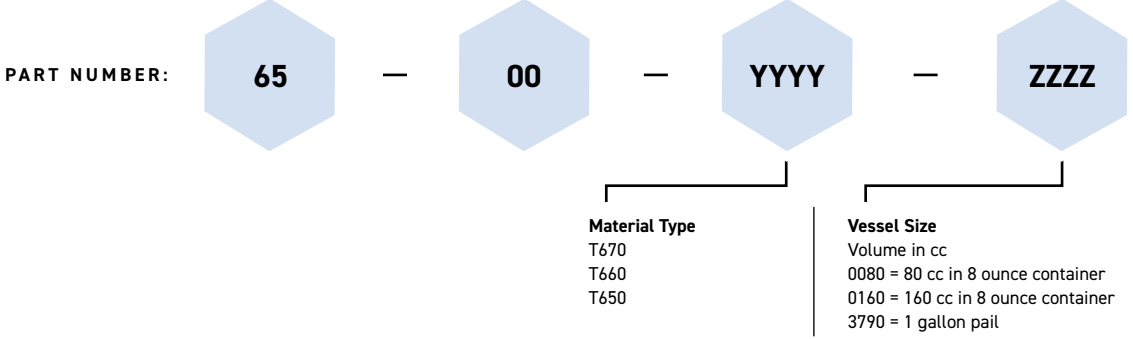

Part Number Examples
 65-00-T650-0160 = T650 Material (160 cc) in an 8 ounce container
 65-00-T670-3790 = T670 Material in a 3790 cc (gallon) pail



Thermal Interface Material Dispensing Guide

for Thermally Conductive Gels, Cure-in-Place Potting Compounds and Thermal Greases



Introduction

Parker Chomerics thermal interface material dispensable products are ideal solutions for today's electronic packages. Thermally conductive, dispensable materials have the ability to cover a variety of gaps and form complex geometries.

This ability to conform provides reduced thermal contact resistances and thus reduces the temperature and increases the efficiency of the electronic application, while providing low closure force. When using dispensable products, specifiers should consider factors such as pump equipment, mating surfaces, tolerance stack up, closure force and physical application of the material.

There are many options for dispensing equipment, ranging from manual syringes to high-volume automated dispensing systems. The choice of the proper equipment

will depend on several factors, including volume, labor/equipment cost, precision requirements and material type to be dispensed. When choosing the appropriate dispensing equipment, designers should keep in mind how the equipment may interact with the material. The material and the delivery system need to be compatible to optimize equipment life and maintain material properties.

To achieve high thermal conductivity, our thermal materials are filled with ceramic particles. Due to this loading, the thermal compounds are highly viscous and may be abrasive. Therefore, they will dispense differently than common low-viscosity greases or adhesives. Once the proper equipment is chosen, certain factors should be considered to increase

the quality and throughput of the material. These factors may include needle/nozzle height, dispensing pattern, dispensing speed, needle diameter, substrate surface finish, etc.

The intent of this guide is to help the user select Parker Chomerics thermally conductive dispensable materials and dispensing equipment and better understand the dispensing process.



Overview of Dispensable Materials



THERM-A-GAP™ Gels

Dispensable, Very Low Compression Force, Thermal Gap Fillers

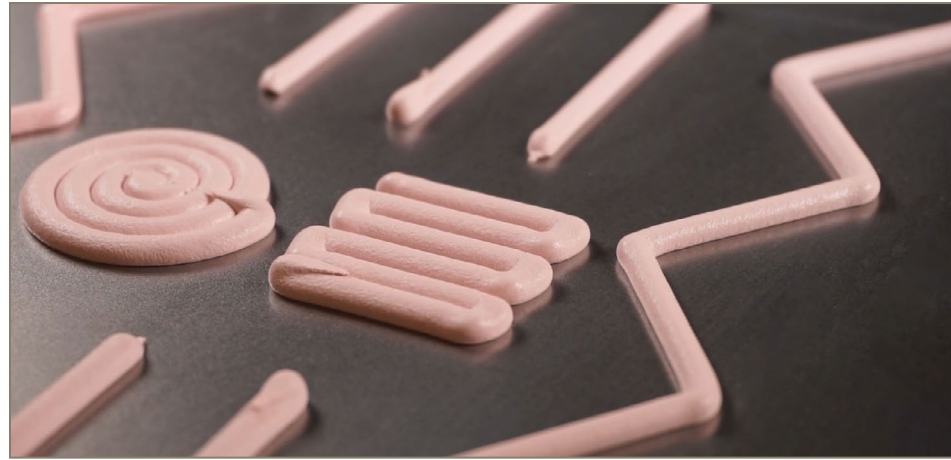

THERM-A-GAP™ Gels are high-performance, single-component, dispensable thermal materials that are either fully cured or require no curing. These unique gel materials result in much lower mechanical stress on delicate components than even the softest gap-filling pads.

These gels are highly conformable and provide low thermal impedance like greases but are designed to overcome the pump-out and dry-out issues associated with grease. THERM-A-GAP Gels are designed to be dispensed in applications requiring low compression forces and minimal thermal resistance for maximum thermal performance. They are ideal for filling variable thickness gaps in a single application.

FEATURES / BENEFITS

- Fully cured or require no curing
- Requires no refrigeration, mixing or additional curing
- Proven long-term reliability and superior performance
- No settling occurs in storage

HIGHLY CONFORMABLE AT LOW PRESSURES

- Ideal for multiple thickness gaps under one common heat sink
- Applies very low stress on components, which makes it ideal for delicate applications
- Allows for design flexibility compared to thermal pads

ONE-COMPONENT DISPENSABLE

- Eliminates hand assembly
- Decreases installation cost
- Eliminates multiple pad part sizes/numbers

EXCELLENT SURFACE WETTING

- Excellent for maintaining contact through thermal cycling

TYPICAL APPLICATIONS

- Automotive electronic control units (ECUs)
- Engine, transmission and braking/traction controls
- Power conversion equipment
- Power supplies and uninterruptable power supplies
- Power semiconductors
- MOSFET arrays with common heat sinks
- Televisions and consumer electronics

STORAGE CONDITIONS

- Materials should be stored at 50 to 90°F (10 to 32°C) at 50% relative humidity.

Overview of Dispensable Materials



THERM-A-FORM™

Cure-in-Place Potting and Underfill Materials

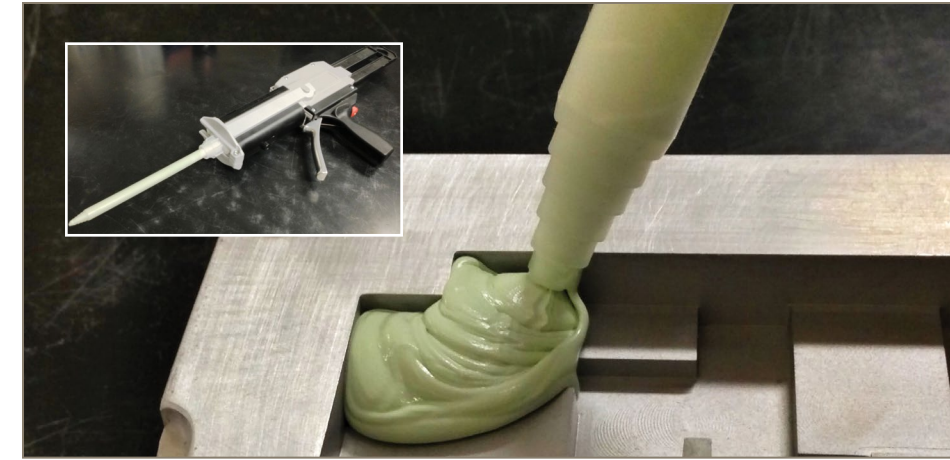

THERM-A-FORM™ Cure-In-Place (CIP) compounds are thermally conductive dispensed silicone elastomer products designed for heat transfer without excessive compressive force in electronics cooling applications. Unlike THERM-A-GAP Gels, which are either pre-cured or require no curing, THERM-A-FORM materials require curing, hence their name "cure-in-place."

THERM-A-FORM Cure-In-Place dispensable compounds are RTV (room temperature vulcanizing) liquid materials which can be dispensed and then cured into complex geometries for cooling of multi-height components on a PCB. Each compound is available in ready-to-use cartridge systems, eliminating weighing, mixing and degassing procedures.

FEATURES / BENEFITS

CURE-IN-PLACE DISPENSABLE COMPOUNDS

- Filling, potting, overfill, under fill, sealing and encapsulating
- Flows around complex parts
- Ideal for multiple thickness gaps under one common heat sink

- Can cure at elevated heat cycle or at room temperature
- Localized encapsulating of components
- Ceramic particles act as natural standoffs for electrical isolation
- Room temperature and elevated cure available

PERFORMANCE GUIDE



CONFORMABLE (LOW MODULUS)

- Mold to complex irregular shapes without excessive force on components
- Insulates against shock and vibration

TYPICAL APPLICATIONS

- Power conversion equipment
- Power supplies and uninterruptable power supplies
- LED modules & power drivers
- Telecom base stations

STORAGE CONDITIONS

- To maintain uniformity, tubes/cartridges should be stored horizontally. Remixing prior to dispensing is not advised, unless the material can be vacuum degassed, to remove any air bubbles. They should be stored



Thermal Greases



TYPICAL APPLICATIONS

- LED modules
- Microprocessors (mobile servers & desktops)
- Memory modules
- DC/DC converters
- Power semiconductors
- Telecom base stations

STORAGE CONDITIONS

- Material may settle overtime in storage. Best practice is to remix the material prior to use. Materials should be stored at 50 to 90°F (10 to 32°C) at 50% relative humidity.

Parker Chomerics thermal greases offer a range of performance covering the simplest to the most demanding thermal requirements. These materials are screened, stenciled or dispensed and require virtually no compressive force to conform under typical assembly pressures. They are excellent for conforming to surface micro-voids created by machining/casting to reduce thermal impedance.

Thermal greases have excellent surface wetting characteristics and flow easily to fill voids at the interfaces resulting in low thermal impedance even at low pressure.

FEATURES / BENEFITS

HIGHLY CONFORMABLE

- Low thermal impedance
- Deflects under minimal compressive forces
- Great surface wetting
- Excellent ability to fill micro-voids

ONE COMPONENT

- Excellent for screening and stenciling
- Requires no cure cycle

PERFORMANCE GUIDE

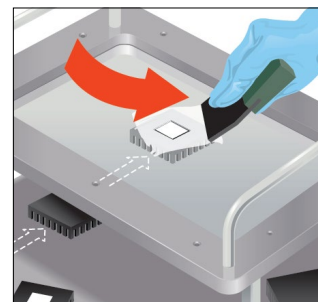
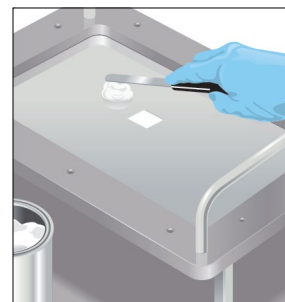
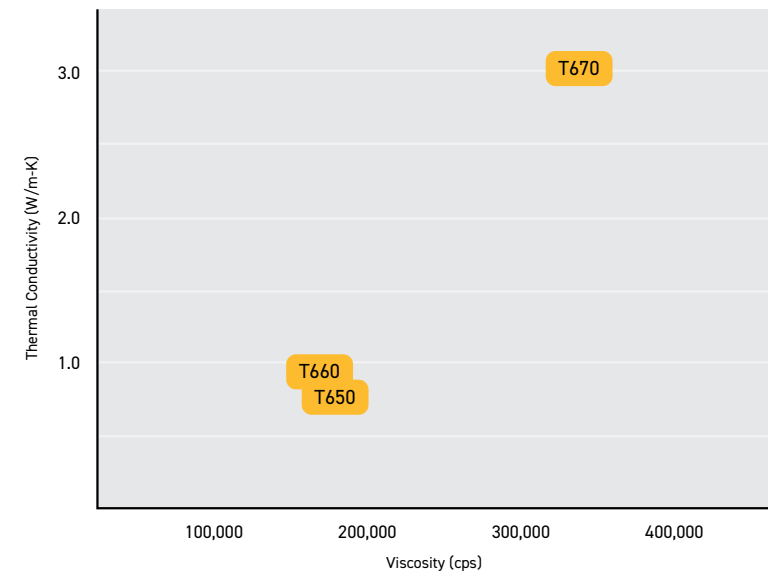
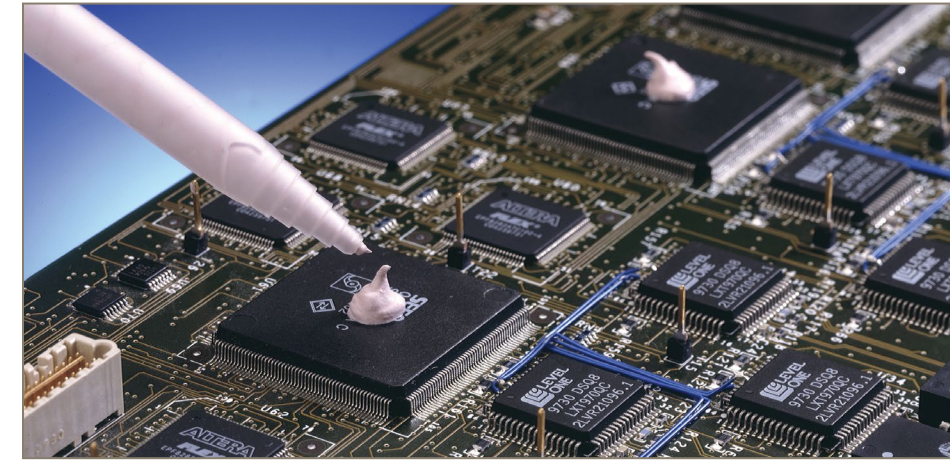

Figure 1: Stenciling Typical application method is to stencil the compound onto the chip or heat-sink. Application patterns can vary depending on the area of coverage. The image above depicts a typical square grease pattern being applied onto a heat-sink with a squeegee or spatula.

Material Selection

Choosing a Thermal Interface Material (TIM) and Dispensing Method



When designing in a dispensable TIM, there are several considerations to keep in mind when determining the appropriate product. The main purpose of the material is to conduct heat, but with a dispensable TIM, there is more to the selection process than simply evaluating thermal conductivities.

Temperature and Environment

To choose the appropriate material for the application, there has to be an understanding of the heat generation that must be dissipated, as well as environmental conditions and limits. Occasionally there are substrates that limit the temperatures that be used for curing a THERM-A-FORM cure-in-place material. Other applications (automotive, under-the-hood) may present high vibration exposure or extreme temperature cycling that would restrict the type of material that can be used. For example, a THERM-A-GAP Gel material may be selected over a cure-in-place material in applications with extreme thermal shock and vibration because of its inherent tack and elasticity.

Dielectric Strength

Parker Chomerics thermal interface materials are comprised of resins and ceramic fillers that are inherently electrically isolating. The largest filler particles will dictate the minimum gap that can be achieved to prevent direct contact of electrical component to heat-spreader.

Package Size

Parker Chomerics offers various packaging formats and sizes. Selection of the appropriate format will be a function of throughput, shot size and expected change over time, as well as compatibility with dispensing equipment. Custom packaging may be available upon request.

Mechanical

The nominal gap and expected variation in gap will dictate the amount, or thickness, of TIM required. Forces generated by expansion/contraction or vibration, coupled material hardness, will result in stress on components. Selection of a soft, conformable material with appropriate thickness will minimize potential damage to critical components.

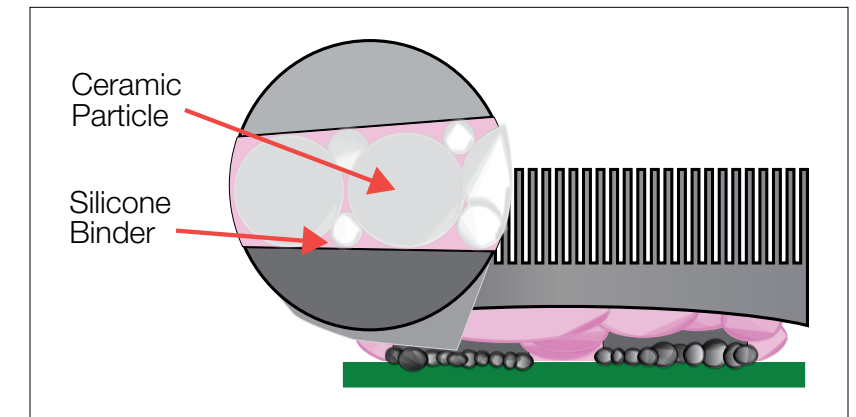

Figure 2: Electrical Isolation Typical ceramic particles shown as natural mechanical stand-offs for electrical isolation.

Equipment Types

Table 1: Low-Volume Dispensing Methods

	Jar or Container	Manual Hand Dispensing		Cartridge Caulking Gun			Shot Size Controllers	
		Single Component Syringe	Mixpac™ with Static Mixer	Manual	Battery Powered	Air or Pneumatic	Pressure/Time	Positive Displacement
Features & Benefits	No capital, immediate installations, small & portable, versatile with tip attachment, no purging required					No capital, small & portable, ergonomically preferred	Repeatable shot size, no purging, versatile tip geometry	Precision shot size control, no purging, versatile tip geometry, improved bead termination
Operator Responsibility	Dispensed size, cycle-time, location & shape	Dispensed size, cycle-time, pressure, location & shape		Dispensed size, cycle-time, pressure, location & shape	Dispensed size, cycle-time, location & shape	Dispensed size, location & shape	Location & shape	
Variability in Dispensed Part	Size, shape, rate & location			Size, shape, rate & location	Size, shape & location	Size, shape & location	Location & shape	
Parker Chomerics Material Package Description	1.4 cc & 120 cc (1 pint with vial)	1-10 cc Syringe	10:1 35-250 cc 1:1 45-200 cc Cartridge with static mixer	300 cc Aluminum cartridge		30-360 cc Cartridge	30-360 cc Cartridge	
Material Cost	Larger bulk containers are the most economical price per cc							
Common Equipment Vendors	None	None	Sulzer Mixpac™	Albion, SEMCO®	Albion	Albion & SEMCO®	Nordson EFD, SEMCO® & Fisnar	Fishman, PVA, Nordson EFD
Equipment Description	None		B System (35 cc & 45 cc Sulzer)	B26 (Albion)	846-1E (Albion)	846-1A (Albion)	Performus I, Performus X100 Dispensers (Nordson EFD)	TBD
			F System (200 cc & 250 cc Sulzer)	850 (SEMCO®)	TBD	250-A & 550 (SEMCO®)	DSP501N & JB1113N (Fisnar)	TBD
							250-B (SEMCO®)	TBD
							TBD	TBD
Comments	For Stenciling use a die-cut mylar that is thicker than the minimum bond-line thickness	Hand-held syringe	Manual dispense system with appropriate mix-ratio (material dependent).	Manual caulking gun may dispense faster depending on the operator.	Battery-powered caulking gun may dispense faster depending on the operator.	Air-powered caulking gun may dispense faster depending on the operator.	Table top unit, that can handle high viscosity compounds and regulates pressure and time. Flow rate is measured at 90 psi directly out of the cartridge.	Table-top unit, that can handle high viscosity compounds and regulates displacement.

NOTE: Parker Chomerics does not officially endorse any of the equipment above or supply it. For equipment technical support please contact the vendors listed. SEMCO is a registered trademark of PPG Aerospace. Mixpac is a trademark of Sulzer.

Equipment Types

Table 2: High-Volume Dispensing Methods

	Bench-Top Dispensing Systems	High-Volume Dispensing Module	
		Cartridge Pumping and Robotic Dispense System	Pail Pump and Transport System
Features & Benefits	Repeatable shot size and shape, programmable XYZ direction and speed, continuous dispensing, low capital investments	Fastest cycle type, lowest material cost, visual inspection systems, fully automated system, best control and yield, continuous dispensing, repeatability in shot size & shape	Fastest cycle type, lowest material cost, visual inspection systems, fully automated system, best control and yield, continuous dispensing, repeatability in shot size & shape, multi-process step
Operator Responsibility (Post Programming & General System)	Seating application under dispensing head	Purging dispense system between materials	Purging dispense system between materials
Variability in Dispensed Part	None		
Parker Chomerics Material Package Description	30-360 cc Cartridge	6 oz (180 cc), 8 oz (240 cc), 12 oz (360 cc), 20 oz (610 cc), & 32 oz (953 cc) Cartridge	1-5 Gallon pail
Material Cost	Larger bulk containers are the most economical price per cc		
Common Equipment Vendors	Camelot, Fisnar and Nordson EFD		
Equipment Description	F4200N (Fisnar)	Please contact local territory sales manager or applications engineering for high-volume equipment recommendations	
	I+J4100LF & DSP501A-LF (Fisnar)		
Comments	Programmable table top unit that is compatible with available packaging.	Pump dispenses directly out of the cartridge to dispensing value. Gear pumps and soft metal component pumps are not recommended. Short hoses with minimum ID, and limited bends and elbows are ideal to minimize shear.	Pump dispenses directly out of the pail to dispensing value. Conductive filler is abrasive. Gear pumps and soft metal component pumps are not recommended. Short hoses with minimum ID, and limited bends and elbows are ideal to minimize shear.

NOTE: Parker Chomerics does not officially endorse any of the equipment above or supply it. For equipment technical support please contact the vendors listed.

Technical Parameters

High Volume Equipment Considerations



High volume applications will require an appropriate dispensing system designed for larger package formats (i.e., SEMCO cartridges and pails).

- The proper equipment choice will be a function of geometry, throughput requirements, material type and package.
- Material selection should be defined *prior* to selecting equipment to optimize material performance and long-term equipment maintenance.

Most thermal interface materials contain high concentrations of ceramic filler to maximize their thermal performance, so they dispense differently than unfilled polymers or greases. THERM-A-GAP Gels are unique materials, in that they are thermally conductive polymers that are either fully cured or require no post cure and can be extruded.

The advantage in using THERM-A-GAP Gels is that they do not require any mixing or curing once they are dispensed.

- To maintain the material's integrity as it is dispensed in high volume, the user should minimize tubing lengths, maximize tubing inside diameters and reduce the number of elbows (i.e., bends or angular connections).
- Using a larger-orifice needle tip reduces the amount of shear on the material (please refer to "Technical Parameters: Dispense Patterns & Process Considerations").

To successfully dispense THERM-A-GAP Gels with minimal impact to their physical properties, simple ram/piston pump systems with adequate force capability have proven most reliable.

- It is not recommended to use reciprocating pumps, gear pumps or other complex pumping designs as they can impart excessive stress on the material.
- Pump systems that have high a degree of mechanical interaction with the material may increase

maintenance needs due to the high concentrations of thermally conductive and sometimes abrasive fillers. The valve that dispenses, or controls, the amount of material dispensed needs to be constructed of wear-resistant components to endure a maximum number of cycles.

The most successful valves use a progressive cavity (i.e., displacement type option) and are geometrically simple. Other features that are available in valves, including a "snuff-back design" as well as built-in shot-size calibration/control, can aid in the termination of the dispensed bead.

THERM-A-FORM CIP materials are two-component materials and require similar equipment design as THERM-A-GAP Gels, but must also take into consideration mixing, metering and curing.

- THERM-A-FORM materials require maximizing the tubing's inside diameter while minimizing tube lengths and number of elbows used (i.e., bends or angular connections).
- Mix carefully so as not to introduce any air voids – can also be done under vacuum.
- Use a static mixer to blend both components of the material.
- Metering, ensuring the proper amount of each side is blended, must be accurate to maintain the material's end properties.

Technical Parameters

Part Considerations

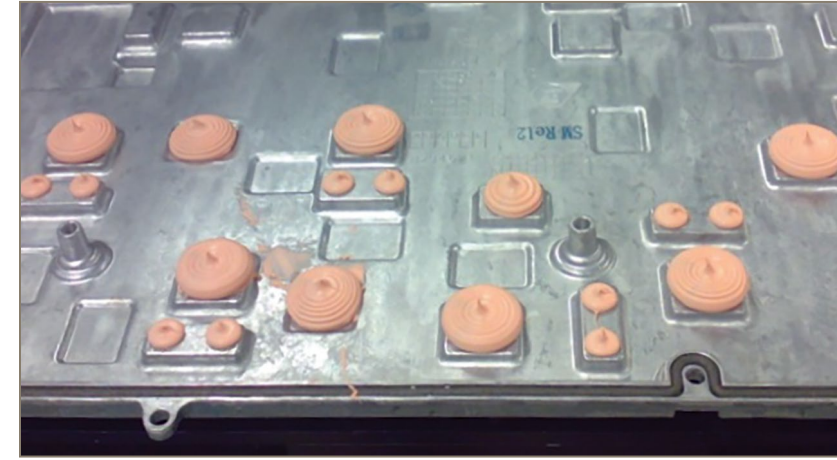

Once a thermal interface material (TIM) has been selected and the dispensing system has been defined, the next step is to analyze the part(s) to ensure that the correct volume of TIM is delivered to the required location in the correct shape.

As a starting point, use the following tasks to guide part analysis:

- Define number of target locations.
- Determine whether the TIM will be dispensed on the component side or heat sink side.
- Consider all operations that occur post-dispense and prior to final assembly that may affect form, placement, cleanliness, position, etc.
- Define dispense technique (this is a function of TIM type, geometry, etc.) Examples include screening, potting, injection and direct dispense to target.
- Consider any physical obstructions that the dispense head will have to navigate around.

Assess the special conditions that the TIM will be subject to (please refer to "Technical Parameters: Special Material Considerations").

- Orientation, vibration, mechanical stresses and temperature extremes
- Cure conditions when high temperature cure is required for a THERM-A-FORM CIP, with low melt materials in proximity
- Transporting of part to multiple locations, i.e., packaging, climate, protection, etc.

Surface Roughness Values		
Grade number	Micro-meter	Micro inches
N8	3.2	125
N9	6.3	250

Table 3: A surface roughness of N8 or rougher is recommended



Figure 4: Multiple location casting

Technical Parameters

Dispense Patterns & Process Considerations

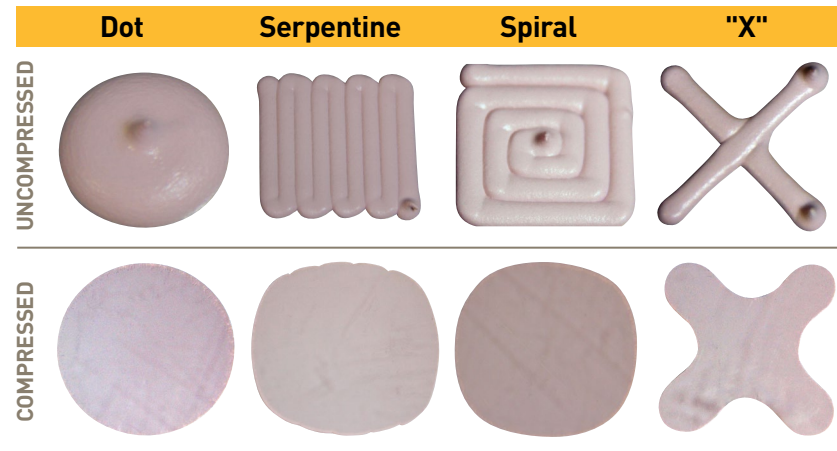

Figure 5: Dispensing Patterns A simple dot like the first pattern provides adequate coverage, shortest cycle time and least chance of introducing air into the TIM. The more complex the profile, the greater the probability for introducing air (e.g., serpentine and spiral).

To maximize thermal performance, the thermal material must contact the entire target area on both the component and heat sink surfaces without air entrapment. In order to achieve this, a proper dispense pattern is critical.

Taking part considerations into account (as discussed on the previous page), the next process design task is to specify the dispensed material pattern.

Consider the following parameters:

- Volume required – a function of the nominal gap, tolerances and geometries
- Shape of bead required to “wet out” the entire targeted area
- Shot location and registration
- Elimination of potential trapped air

Process verification:

- Visual inspection (if possible)
- Automatic/integrated optical verification
- Functional tests (measurement of critical junction temperatures as a function of power)

Achieve repeatable shot volume:

- If repeatability is inadequate, consider the effect of the dispense tip, the effect of shear and time, the effect of cure (if it is a CIP material) and the effect of adding a precision valve (if necessary).
- Always establish a minimum volume that is required to cover the entire range of gap volumes.
- Build in a shot-size calibration process to verify that dispense rates are not variable. Adjust dispense pressure or shot times as a function of shot-size measurements.

Optimize the shape of the dispensed material:

- Determine a dispense pattern (dot, line or serpentine) that will “wet” the entire target, and that offers a bead height enough to fully contact the opposing target surface without air voids
- Consider the path of egress to minimize any possible air entrapment.
- Optimization of pattern can reduce material consumption while ensuring the functional gap is filled.

To properly locate (or register) the dispensed material to the part:

- Start with a proper fixturing and adjustment scheme to ensure registration between dispense head and part.
- Build appropriate verification checks into the process.

To optimize cycle time:

- Adjust dispense pressure (increase), needle orifice diameter (increase) and hose lengths/angles/flow obstructions of the delivery system (decrease).
- Beware of trade-offs associated with improvement of flow and cycle time, such as effects of shear on the material, sag/slump behavior, effects on shape of pattern and filler separation in delivery system (damming).

Technical Parameters

Surface Wetting

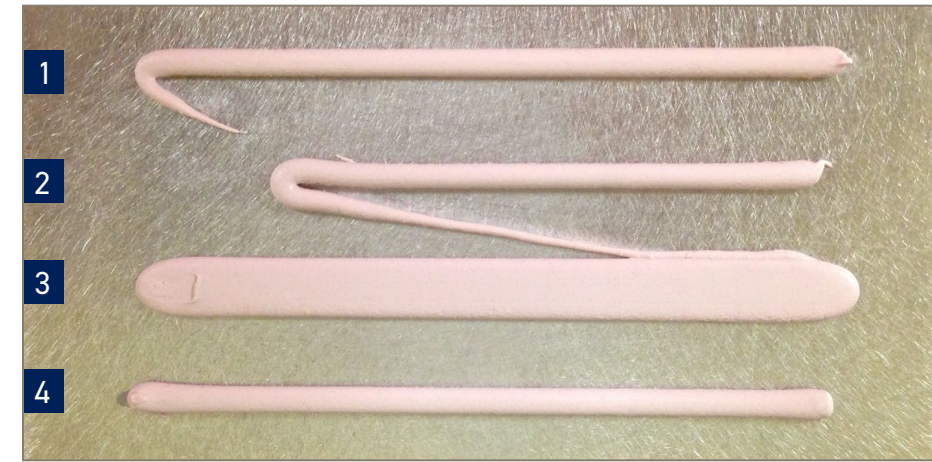

Figure 6: Common Line Dispensing Concerns Common dispensing issues: (1, top) system did not have a program for bead termination; (2, middle top) needle was too high and there was no bead termination programmed; (3, middle bottom) needle too low; (4, bottom) correct height with bead termination.

Proper adherence starts with a clean surface. Confirm that your part's surface is free of lint, processing oils and FOD (foreign object debris). If there is a concern with cleanliness, the surface can be cleaned with a mild solvent, such as isopropyl alcohol (IPA), or any suitable surface cleaner.

The objective is to have the dispense tip as low as possible to achieve sufficient wetting and bead initiation/termination (see figure 6). This may require some dispensing trials to determine the appropriate combination of dispense tip diameter, height and corresponding speed and service pressure.

- Be sure to target each bead shape and volume to properly wet and fill the gap between the two surfaces.
- Consider a bead height of 2X to 3X the nominal gap to promote wetting.

As a general rule, increased surface roughness will increase the surface area available for wetting. In vertical applications, the increased surface

roughness will provide an increased resistance to slide. For additional technical support regarding vertical gap dispensing, please contact Parker Chomerics Applications Engineering.

- Increasing the shot size, contact area and surface roughness will aid in slide resistance of the material.

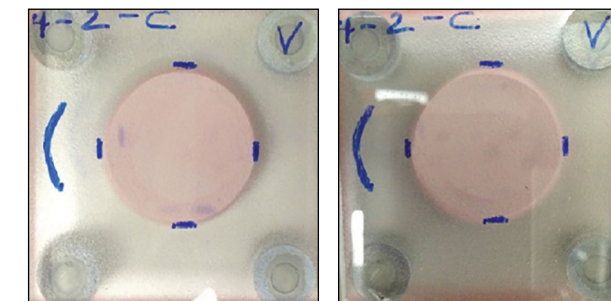

Figure 7: Reliability Reports The images above show one of the 18 trials that were performed on THERM-A-GAP Gel 30 in a vertical orientation tested under several different surface roughnesses, gaps and surface areas. The test fixtures were subject to temperature shock and random vibration. Contact Parker Chomerics Applications for report. (Image to the left is before and Image to the right is after the treatment.)

- Staging time (prior to further processing) will enhance wetting of the material to the target surfaces (i.e., component, heat spreader).

For re-work:

- First remove the bulk of the material using a soft tool that will not damage the substrate (i.e., a rubber spatula, tongue depressor).
- Apply a mild surface cleaner such as IPA to remove remaining residue and clean the surface, then reapply the TIM.

As THERM-A-GAP Gel materials are either pre-cured or do not require a cure, THERM-A-FORM cure-in-place materials may be more difficult to peel once they cure.

The best way to remove the THERM-A-FORM material is to abrade the surface with a soft tool (wooden stick or cotton swab) and then clean the surface with IPA (toluene may work better).

Technical Parameters

Special Material Considerations



THERM-A-GAP GELS are filled elastomers that are either fully cured or do not require post cure and are loosely cross-linked and can easily be extruded. Excessive shear force from complex dispense geometries and high pressure can affect the material structure and affect the rheology of the material.

- It is important to minimize the degree of shear imparted on THERM-A-GAP Gels during application by using a needle with a larger orifice, larger inner diameter tubing, fewer elbows and lower pressure.

Due to this sensitivity to shear, THERM-A-GAP Gels are designed to be dispensed out of the packaging *only once*. Repackaging would change the mechanical properties of the material.

For THERM-A-GAP Gel rework:

- Use a cloth, lint-free towel or spatula to remove the THERM-A-GAP Gels from the substrate.
- After the material is removed, fresh material should be reapplied.

THERM-A-FORM CIP (Cure-In-Place) compounds are designed to be dispensed and cured directly into the application.

- Surfaces should be free from any cure-inhibiting contaminants, especially those containing:
 - Nitrogen
 - Sulfur
 - Tin
 - Phosphorus
 - Latex

It is important to consider cure times and temperatures required to fully cure the material, and their effect on processing, cycle times and substrates.

- Every 10°C (50°F) increase in cure temperature will reduce the cycle to half of the original time (keeping in mind the exposure limits of other components).

THERM-A-FORM pot life considerations:

- Once catalyzed, there is a finite amount of time that the material will flow adequately.

- Proper measures must be addressed to ensure shot size control.
- Static mixing nozzles are provided with all standard two-component THERM-A-FORM products.
- Use the appropriate static mixing nozzle as they differ with mix ratio (i.e., 1:1 and 10:1).

For THERM-A-FORM compound rework:

Components encapsulated by a THERM-A-FORM compound can be removed by notching and peeling away the cured compound from the components.

Thermal Greases were designed to achieve minimum bond-line.

- Typical application is through stenciling or screen printing.
- Be sure that the screen or stencil is a minimum of 3X thicker than the maximum particle size in the compound.

If the holes of the screen are too small or the stencil is too thin, it may filter out some of the thermally conductive particles in the grease. Due to the non-crosslinked nature of thermal greases, they may tend to separate in the package. It is best practice to always mix the material prior to use.

For Thermal Grease rework:

- Thermal greases can be removed with a simple cleaning solvent prior to reapplying.

Packaging Options

Table 4 - Packaging Options

Code	Packaging Options Pictured Below	Standard Fill Level (cc)
A	30 cc Taper Tip Cartridge	27
B	30 cc Optimum Cartridge/Tip	27
C	35 cc Cartridge Kit (10:1) w/ Static Mixer	34/3.4
D	45 cc Cartridge Kit (1:1) w/ Static Mixer	22/22
E	200 cc Cartridge Kit (1:1)	95/95
F	250 cc Cartridge Kit (10:1) w/ Static Mixer	244/2.4
G	300 cc Aluminum Caulking Tube (13 oz)	300
H	6 oz SEMCO	150
I	6 oz EFD	150
J	20 EFD	320
K	20 oz SEMCO	570
L	1 Gallon Pail	3250
Code	Packaging Options Not Pictured	Standard Fill Level (cc)
M	10 cc Syringe w/ Cap	10
N	4 oz Primer Vial	118
O	1.4 cc Jar	1.4
P	2.5 cc Tube	2.5
Q	55 cc Optimum® Cartridge	52
R	8 oz SEMCO	225
S	8 oz Plastic Jar	80/160 for greases
T	12 oz SEMCO	320
U	20 oz SEMCO	570
V	32 oz SEMCO	900
W	32 oz EFD	900
X	5 Gallon Pail	7800

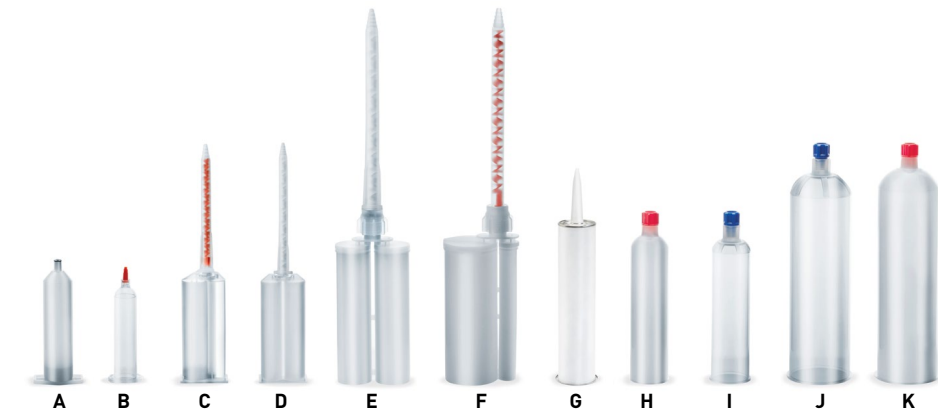

Figure 8: Typical packaging options



Figure 9: Typical high-volume packaging options

Heat Transfer Fundamentals & Thermal Management Glossary



Heat Transfer Fundamentals

The objective of thermal management programs in electronic packaging is the efficient removal of heat from the semiconductor junction to the ambient environment.

This process can be separated into three major phases:

1. heat transfer within the semiconductor component package;
2. heat transfer from the package to a heat dissipater (the initial heat sink);
3. heat transfer from the heat dissipater to the ambient environment (the ultimate heat sink)

The first phase is generally beyond the control of the system level thermal engineer because the package type defines the internal heat transfer processes. In the second and third phases, the packaging engineer's goal is to design an efficient thermal connection from the package surface to the initial heat spreader and on to the ambient environment. Achieving this goal requires a thorough understanding of heat transfer fundamentals as well as knowledge of available interface materials and how their key physical properties affect the heat transfer process.

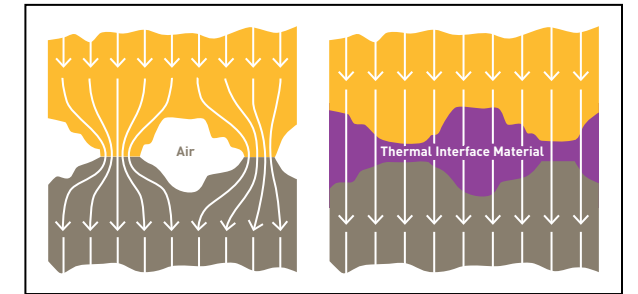

Figure 1a. Schematic representation of two surfaces in contact and heat flow across the interface without (left) and with thermal interface material applied.

BASIC THEORY

The rate at which heat is conducted through a material is proportional to the area normal to the heat flow and to the temperature gradient along the heat flow path. For a one dimensional, steady state heat flow the rate is expressed by Fourier's equation:

$$\text{Equation 1 } Q = k A \frac{\Delta T}{d}$$

Where:

- k = thermal conductivity, W/m-K
- Q = rate of heat flow, W
- A = contact area, m²
- d = distance of heat flow, m
- T = temperature difference, C

Thermal conductivity, k, is an intrinsic property of a homogeneous material which describes the material's ability to conduct heat. This property is independent of material size, shape or orientation. For non-homogeneous materials, those having glass mesh or polymer film reinforcement, the term "relative thermal conductivity" is appropriate because the thermal conductivity of these materials depends on the relative thickness of the layers and their orientation with respect to heat flow.

Another inherent thermal property of

a material is its thermal resistance, R, as defined in Equation 2.

$$\text{Equation 2 } R = A \frac{\Delta T}{Q}$$

This property is a measure of how a material of a specific thickness resists the flow of heat. The relationship between k and R is shown by substituting Equation (2) into (1) and rearranging to form (3)

$$\text{Equation 3 } k = \frac{d}{R}$$

Equation 3 shows that for homogeneous materials, thermal resistance is directly proportional to thickness. For non-homogeneous materials, the resistance generally increases with thickness but the relationship may not be exactly linear.

Thermal conductivity and thermal resistance describe heat transfer within a material once heat has entered the material. Because real surfaces are never truly flat or smooth, the contact plane between a surface and a material can also produce a resistance to the flow of heat. Figure 1a depicts surface irregularities on a micro scale and surface warp on a macro scale. Actual contact occurs at the high points, leaving air-filled voids

where the valleys align. Air voids resist the flow of heat and force more of the heat to flow through the contact points. This constriction resistance is referred to as surface contact resistance (R_{contact}) and can be a factor at all contacting surfaces.

The thermal impedance [θ] of a material is defined as the sum of its thermal resistance (R_{material}) and any contact resistance (R_{contact}) between it and the contacting surfaces as defined in Equation 4.

$$\text{Equation 4 } \theta = R_{\text{material}} + R_{\text{contact}}$$

Surface flatness, surface roughness, clamping pressure, material thickness, the presence of pressure sensitive adhesive (PSA) and compressive modulus have a major impact on contact resistance. Because these surface conditions can vary from application to application, thermal impedance of a material will also be application dependent.

THERMAL INTERFACE MATERIALS (TIMs)

Heat generated by a semiconductor must be removed to the ambient environment to maintain the junction temperature of the component within safe operating limits. Often this heat removal process involves conduction from a package surface to a heat spreader that can more efficiently transfer the heat to the ambient environment. The spreader has to be carefully joined to the package to minimize the thermal resistance of this newly formed thermal joint.

Attaching a heat spreader to a semiconductor package surface

requires that two commercial grade surfaces be brought into intimate contact. These surfaces are usually characterized by a microscopic surface roughness superimposed on a macroscopic non-planarity that can give the surfaces a concave, convex or twisted shape. When two such surfaces are joined, contact occurs only at the high points. The low points form air-filled voids. Typical contact area can consist of more than 90 percent air voids, which represents a significant resistance to heat flow.

Thermally conductive materials are

used to eliminate these interstitial air gaps from the interface by conforming to the rough and uneven mating surfaces. Because the TIM has a greater thermal conductivity than the air it replaces, the resistance across the joint decreases, and the component junction temperature will be reduced. A variety of material types have been developed in response to the changing needs of the electronic packaging market.

KEY PROPERTIES OF THERMAL INTERFACE MATERIALS

THERMAL PROPERTIES

The key properties of interface materials are thermal impedance and thermal conductivity.

THERMAL IMPEDANCE

This is the measure of the total resistance to the flow of heat from a hot surface through an interface material into a cold surface. Thermal impedance is measured according to the ASTM D5470 test method. Although the current version of this method is specific to high durometer insulating pad materials tested at high clamping forces, the method has been successfully adapted for use with low durometer materials as well as fluid compounds.

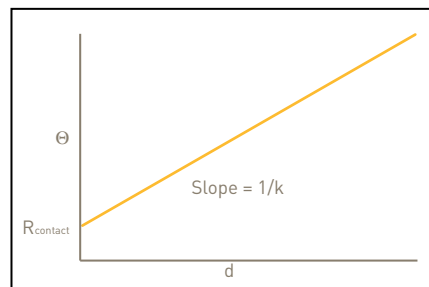

Figure 2. Thermal Impedance vs. Thickness

Thermal impedance can be measured using ASTM D5470 at several clamping forces to generate a pressure versus thermal impedance plot as shown in Figure 2. This type of data can be used to generate information about the ability of a material to conform to surfaces to minimize contact resistance. Care must be taken with this type of data because contact resistance is also highly influenced by surface characteristics. To minimize the impact of test equipment variations, this type of work is best performed with the same test surfaces for all materials being tested.

THERMAL CONDUCTIVITY

Thermal impedance data measured according to ASTM D5470 can be used to calculate the thermal conductivity of an interface material. Rearranging Equation (3) to give Equation (5)

$$\text{Equation 5 } R_{\text{material}} = \frac{d}{k}$$

and substituting into Equation (4) yields Equation (6).

$$\text{Equation 6 } \Theta = \frac{d}{k} + R_{\text{contact}}$$

Equation (6) shows that for a homogeneous material, a plot of thermal impedance [Θ] versus thickness (d) is a straight line whose slope is equal to the inverse of the thermal conductivity and the intercept at zero thickness is the contact resistance shown in Figure 2. Thickness can be varied by either stacking up different layers of the material or by preparing the material at different thicknesses.

COEFFICIENT OF THERMAL EXPANSION

CTE is the tendency of a material to change in volume in response to changes in temperature.

HEAT CAPACITY

Heat capacity or thermal mass represents the ability of a material to store heat.

ELECTRICAL PROPERTIES

VOLTAGE BREAKDOWN

This is a measure of how much voltage differential a material can withstand under a specific set of test conditions. This property is usually measured using ASTM D149 where a test specimen is subjected to ramped alternating current voltage such that dielectric failure is reached within 20 seconds after the start of the test. Five specimens are tested and the average voltage breakdown is calculated and reported. The value is an average, not a minimum. Voltage Breakdown can be converted to Dielectric Strength by dividing the voltage breakdown value by the specimen thickness where the dielectric failure occurred. This test is an indication of the ability of a material to withstand high voltages, but does not guarantee how a material will behave over time in a real application. The value is influenced by several factors. Humidity and elevated temperature will reduce the voltage breakdown because absorbed water will degrade the electrical properties of the material.

The size of the test electrode will affect the observed breakdown voltage. A larger test electrode will typically yield a lower breakdown voltage. The presence of partial discharge, as well as mechanical stresses imposed on the interface material, also reduce voltage breakdown.

From	Cal sec-cm-°C		BTU-in hr-ft ² -°F		W m-k	
Multiplier	4.2 x 10 ²	2.9 x 10 ³	0.14	3.4 x 10 ⁻⁴	6.94	2.4 x 10 ⁻³
To	W m-k	BTU-in hr-ft ² -°F	W m-k	Cal sec-cm-°C	BTU-in hr-ft ² -°F	Cal sec-cm-°C

Thermal Conductivity Conversion Guide

VOLUME RESISTIVITY

Volume resistivity is a measure of the bulk electrical resistance of a unit cube of a material. When determined per ASTM D257, volume resistivity can give an indication of how well an interface material can limit leakage current between an active component and its grounded metal heat sink. As with voltage breakdown, volume resistivity can be significantly lowered by humidity and elevated temperature.

ELASTOMERIC PROPERTIES

Interface materials exhibit properties typical of highly filled elastomers, namely compression deflection, compression set and stress relaxation.

COMPRESSION DEFLECTION

Compression deflection refers to resultant forces a material exerts while being deflected. As a compressive load is applied, the elastomer material is deformed but the volume of the material remains constant. The compression deflection characteristics can vary, depending on part geometry (i.e., thickness and surface area), rate of deflection, size of probe, etc.

STRESS RELAXATION

When a compressive load is applied to an interface material, there is an initial deflection followed by a slow relaxation process whereby some of the load is relieved. This process continues until the compressive load is balanced by the cohesive strength of the material.

COMPRESSION SET

Compression set is the result of stress relaxation. After a material has been subjected to a compressive load for an extended time, part of the deflection becomes permanent and will not be recoverable after the load is reduced.

Thermal Management Glossary

Alumina (Al₂O₃): A relatively inexpensive ceramic in powder or sintered sheet form. Its thermal conductivity of 30 W/m-K and excellent dielectric properties make it useful in low to moderate power commercial applications.

Ambient Temperature: The temperature of the air surrounding a heat source.

Apparent Thermal Conductivity: This value differs from bulk thermal conductivity as apparent thermal conductivity also includes contact resistance when measured, as described in the Heat Transfer Fundamentals section of this guide. Also see Thermal Conductivity.

Arcing: An electrical discharge between the edges of metal semiconductor package and the metal heat sink on which it is mounted.

Binder: A polymer (i.e. silicone, urethanes, acrylic, epoxy etc.) used in thermal interface materials to provide desired mechanical, thermal and electrical properties and hold in a stable form the fillers whose primary purpose is the transfer of heat. Binders are also good electrical insulators.

Bondline Thickness: Average thickness between heat spreading device and components.

Boron Nitride (BN): A non-abrasive ceramic material that has higher thermal conductivity than alumina. Because it is an expensive raw material, it is usually used in high performance interface materials.

Breakdown Voltage: The amount of voltage required to cause a dielectric failure through an insulator when tested under a set of specific conditions. This value does not imply that the insulator can be operated at those voltages.

Burr: A thin ragged fin left on the edge of a piece of metal (semiconductor package or heat sink) by a cutting or punching tool.

Calorie: A unit of energy equal to the quantity of heat required to raise the temperature of 1 gram of water by one degree Celsius.

Ceramic: A name given to oxides of metals. Ceramics are usually hard, heat and corrosion resistant and high dielectric strength powders that can be formed into shapes by fusion or sintering.

Chamfer: A bevel cut into the edge of heat sink mounting holes.

Coefficient of Thermal Expansion (CTE): A measure of a material's change in volume in response to a change in temperature.

Compression Set: The permanent deformation of an elastomeric material caused by a compressive force.

Conduction: The transfer of heat energy through matter.

Convection: The transfer of heat that results from motion of a fluid (gas or liquid).

Corona: An electrical discharge within or on an insulator accompanied by ionization of the air within or contacting the surface of the insulator. Also called partial discharge. It is the main mode of insulation failure exposed to long term AC voltages.

Creep Distance: The distance that an insulator has to extend beyond the edge of a semiconductor package to prevent arcing.

Cure-In-Place: Any material that is dispensed as a liquid and cures in the application.

Cut-Through: A phenomenon that occurs when sharp edges or burrs on the metal semiconductor package or heat sink cut through the thermal pads and reduce or eliminate their insulating strength.

Compression/Deflection: The change in thickness of an elastomeric interface material in response to a compressive load. Because these materials are incompressible, deflection is accompanied by a proportional increase in area.

Degreaser or Degreasing Solvent: The solvent used to clean flux and other organic residues off printed circuit boards after they are manufactured. Interface materials must be able to tolerate exposure to degreasing

solvents without degrading performance.

Dielectric: A material that acts as an insulator.

Dielectric Constant: See Permittivity.

Dielectric Strength: The voltage gradient, expressed as kV/mm, that will cause a dielectric failure in an insulating material under very specific test conditions. Dielectric strength does not imply that the insulator can withstand those potential gradients for an extended period of time.

Durometer: An instrument for measuring the hardness of rubber. Measures the resistance to the penetration of an indenter point into the surface of the rubber.

Electronic Control Unit or Electronic Control module (ECU/ECM): Various electronic controllers, typically used in automotive applications. (i.e. steering and braking)

Electrical Insulator: A material having high electrical resistivity and high dielectric strength and therefore suitable for separating components at different potentials to prevent electrical contact between them.

Filler: A fine, dispersible ceramic or metallic powder (i.e. boron nitride, alumina, graphite, silver flake, etc.) whose thermal conductivity is at least twenty times greater than that of the binder.

Flow Rate: The volume, mass or weight of a fluid passing through a device of any type, per unit of time, expressed in gallons- or liters-per-hour.

Flux: An organic compound used to enhance the wetting and adhesion of metal solder to the copper surfaces on printed circuit boards.

Footprint: The area of the base of an electronic device which comes in contact with a thermal interface material.

Hard Tooling: A die cutting tool manufactured from a machined metal block. The cost is high, therefore it is normally used when long runs are anticipated.

Thermal Management Glossary

Hardness: A measure of the ability of a material to withstand penetration by a hard pointed object. Regarding thermal interface materials, this property is usually inversely proportional to the ability of a material to conform to uneven surfaces.

Hardness Shore A (Shore D, Shore 00): An instrument reading on a scale of 0 to 100 measuring the hardness of a material. There are three scales: Shore 00, A and D. Shore 00 is used for soft rubbers like gels, Shore A is used for hard rubbers and Shore D for inelastic plastics.

Heat (Q): A form of energy generated by the motion of atoms or molecules. Heat energy is expressed in units of joules.

Heat Capacity: The measure of a material's ability to store heat.

Heat Flow: The rate at which heat is flowing per unit time expressed as Watts.

Heat Flux (Q/A): The rate of heat flow per unit surface area expressed as Watts/cm².

Heat Transfer: The movement of heat from one body to another (solid, liquid, gas, or a combination) by means of conduction, convection, or radiation.

Interface: A boundary that exists between any two contacting surfaces. There are five types of interfaces that can exist between the different forms of matter: gas-liquid, liquid-liquid, gas-solid, liquid-solid, and solid-solid.

Junction: The junction is the active part of a semiconductor, usually silicon, where the current flow causes heat to be generated.

MBLT: Minimum bond line thickness. When two opposing substrates obtain closest possible distance under pressure.

Micro-inch: This unit of measure, a millionth of an inch, is used to describe the roughness of a surface and is the average distance between the peaks and valleys on the surface.

Mil: A unit of length equal to one-thousandth of an inch.

PCM: Abbreviation of phase change material.

Permeability: A measure of a material's ability to align its magnetic domains in response to an applied magnetic field.

Permittivity: A measure of a dielectric material's ability to polarize in response to an applied electric field, and transmit the electric field through the material.

Polyimide: An organic polymer with exceptional electrical insulation and high temperature capabilities. In film form, it is used on everything from printed circuit boards to space suits.

Power Supply: A self contained unit which converts AC current to DC for use in electronic devices.

Pressure Sensitive Adhesive (PSA): An adhesive that is tacky at normal temperatures and requires only slight pressure to form a permanent bond. A PSA requires no further cure to maintain the bond.

PSH: Class of polymer solder hybrid. A synergistic blend of eutectic solder and specialty polymers. They provide a highly reliable thermal interface material with a resin carrier and filler content that both melt to obtain minimum bond line thickness.

Radiation: A heat transfer process whereby heat is given off through electromagnetic radiation, usually infrared rays.

Reinforcement: A woven glass mesh or polymer film that is used as a support in thermal interface materials.

Permanent Set: Permanent Set is defined as the amount of residual displacement in a rubber part after the distorting load has been removed.

Relaxation: Stress Relaxation is a gradual increase in deformation of an elastomer under constant load over time, accompanied by a corresponding reduction in stress level.

Rheology: The science of the deformation and flow of materials.

Semiconductor: An electronic material that can be an insulator under one condition and switch to a conductor under a different condition.

Shear-Thinning: A characteristic of a fluid whereby the fluid's viscosity decreases with increased shear stress. Materials that exhibit shear-thinning are also described as pseudoplastic. Filled polymer resins commonly exhibit this behavior. (Example: toothpaste is shear-thinning. It does not flow when left alone, but when squeezed with increased force, it flows more readily.)

Silicon: A non-metallic element occurring extensively in the earth's crust in silica and silicates. Silicon is the basis for the junction found in most semiconductor devices.

Solder: A mixture of metals that is used to connect electronic devices to the copper patterns on a printed circuit board.

Solvent Resistance: The ability of thermal management products to resist swelling when exposed to organic solvents such as degreasing solvents, hydraulic fluids, coolants and jet fuel.

Specific Gravity: The ratio of the density of a substance to the density of water. The specific gravity of water is 1 at standard condition temperature and pressure.

Specific Heat: The amount of heat per unit mass required to raise the temperature by one degree Celsius. (See Heat Capacity.)

Steel Mill Die: A die cutting tool of moderate cost, cast from steel. It is used for high speed cutting.

Steel Rule Die: A low cost die cutting tool manufactured by shaping sharpened steel foil to the desired shape and fixing in a plywood and steel rule metal. It is used for short runs.

Surface Finish: A measure of the roughness of a surfaces, usually expressed in units of micro-inches.

Swelling: A phenomenon that results when an elastomer is exposed to a degreasing solvent and the elastomer absorbs the solvent. The

Thermal Management Glossary

volume of the elastomer increases and its physical strength is greatly reduced. In this swollen state, the elastomer can be easily damaged and should not be subjected to any mechanical stress until the elastomer has been dried.

Tear Strength: A measure of the ability of a material to withstand tearing/ripping stresses. It is usually measured in pounds force per inch of thickness.

Temperature: A measure of the average kinetic energy of a material. The standard unit of temperature is a Kelvin (K). Temperature determines the direction of heat flow between any two systems in thermal contact. Heat will always flow from the area of higher temperature (T source) to one of lower temperature (T sink).

Temperature Gradient (ΔT): The difference in temperatures in the direction of the heat flow between two points in a system.

Tensile Strength: A measure of the ability of a material to withstand a tension (pulling apart) force. It is usually measured in MPa or psi of material cross section.

Thermal Conductivity (K): A quantitative measure of the ability of a material to conduct heat expressed in units of W/m-K.

Thermal Contact Resistance (Ri): The resistance to the flow of heat caused by interstitial air trapped in the irregularities of between contacting solid surfaces. Units are K-cm²/W.

Thermogravimetric Analysis: Chemical analysis by the measurement of weight changes of a system or compound as a function of increasing temperature.

Thermal Impedance (θ): Thermal impedance is the sum of the thermal resistance of an interface material and the thermal resistances at the interfaces in contact with the material. K-in² /Watt.

Thermal Interface Materials (TIMs): Materials that are inserted between two contacting solid surfaces and aid heat flow by eliminating gaps between the irregular surfaces. Interstitial air is replaced by material that is significantly more conductive than air.

Thermal Resistivity: The quantitative measure of a material's resistance to the conduction of heat. (It is the inverse of thermal conductivity.)

Thermocouple: A thermoelectric device consisting of two dissimilar metallic wires fused into a bead which generates a voltage proportional to the temperature of the bead.

Thixotropy: A characteristic of a fluid whereby the fluid's viscosity decreases as a function of time at a fixed shear rate. Viscosity tends to re-build with time as the shear stress is reduced. (Example: gels and colloids are often thixotropic. The longer they are shaken in a can, the more readily they flow)

Tolerance: The permissible variations in the dimensions or other characteristic of a part or substance.

Torque: A turning or twisting that is equal to the value of the force (f) multiplied by the rotational distance over which it is applied (usually measured in ft-lbs.).

Viscoelastic material: A material whose response to a deforming load combines both viscous (does not recover its original shape/size when load removed) and elastic (will recover size/shape when load removed) qualities. The common name for such a material is "plastic."

Volume Resistivity: A measure of a material's inherent electrical resistance expressed as ohm-cm.

Watt: An SI unit of power equal to one joule per second.

Parker Chomerics Capabilities

Thermal Interface Materials



Thermally Conductive Gap Filler Gels

Highly conformable, high performance fully cured single-component dispensable gap filler ideal for high volume automated dispense processes.

Typical Applications: Telematics, ECU's, EPAS, batteries

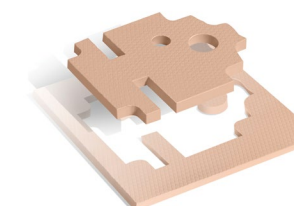

Thermally Conductive Gap Filler Pads

Low modulus thermally conductive gap pads offer ease of use, excellent thermal properties and highest conformability for low to moderate clamping force applications.

Typical Applications: AV systems, ACC, braking, battery ECU's

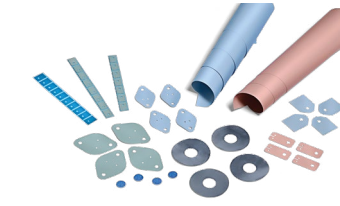

Thermal Insulators

Available in several forms, these materials are designed for use where the highest possible thermal, dielectric and mechanical properties are required.

Typical Applications: Power train, lighting, braking, sensors, ECU's

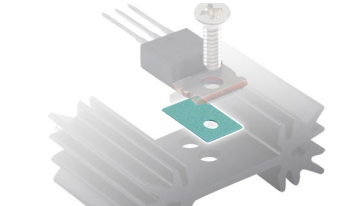

Phase Change Materials

Designed to minimize the thermal resistance between power dissipating electronic components and heat sinks, provide superior long term reliability performance.

Typical Applications: ABS, braking, wipers, transmissions, batteries

EMI Shielding & Grounding



Fabric Over Foam Gaskets

SOFT-SHIELD® EMI gasketing products bring new flexibility to shielding decisions. They offer material choices, performance levels, configurations and attachment methods.

Typical Applications: Telematics, ITE, medical, commercial

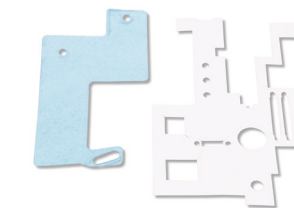

Laminates and Grounding Products

Mechanical, electrical and processing properties plus economy for commercial applications.

Typical Applications: EMI shields, ground planes, ground straps, ESD shields

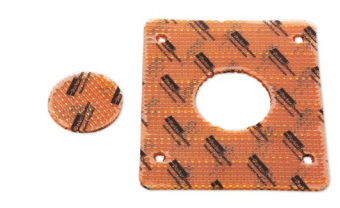

Wire and Expanded Metal Gasketing

Metal-based gaskets solutions for Electromagnetic Interference (EMI) and Electromagnetic Pulse (EMP) shielding as well as lightning strike protection.

Typical Applications: Connectors, cabinets, military

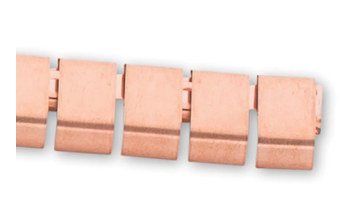

Beryllium Copper and Stainless Steel Gaskets

Beryllium-copper (BeCu) and stainless steel EMI gaskets (SPRING-LINE®) combine high levels of shielding effectiveness with a broad deflection range and low closure force properties.

Typical Applications: Cabinets,

Conductive Compounds



Specialty Materials

Offering a wide variety of adhesives, caulks, sealants and coatings.

Typical Applications: EMI/RFI shielding, component and module caulking and sealing, ITE, medical

Conductive Plastics



Conductive Plastics

Blend of thermoplastic and conductive fillers that provides world class shielding effectiveness and requires no machining, plating, painting or other added processing steps.

Typical Applications: ACC, sensors, batteries

Integrated Display Solutions



CHO-TOUCH Touchscreen LCDs

Parker Chomerics has designed these touchscreen LCDs for harsh environments such as military, medical, avionics, and general industrial.

Typical Applications: Military, medical, aerospace

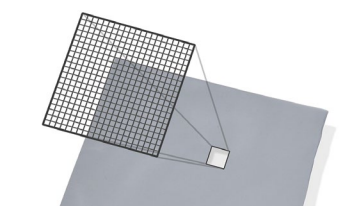

EMI Shielded Touchscreens and Windows

EMI Shielded touchscreens for rugged performance meeting critical EMC needs. Glass and polycarbonate windows for EMI Shielding and mechanical protection.

Typical Applications: Military, medical, aerospace

Offer of Sale

PARKER-HANNIFIN CORPORATION OFFER OF SALE

- Definitions.** As used herein, the following terms have the meanings indicated.
Buyer: means any customer receiving a Quote for Products from Seller.
Goods: means any tangible part, system or component to be supplied by the Seller.
Products: means the Goods, Services and/or Software as described in a Quote provided by the Seller.
Quote: means the offer or proposal made by Seller to Buyer for the supply of Products.
Seller: means Parker-Hannifin Corporation, including all divisions and businesses thereof.
Services: means any services to be supplied by the Seller.
Software: means any software related to the Products, whether embedded or separately downloaded.
Terms: means the terms and conditions of this Offer of Sale or any newer version of the same as published by Seller electronically at www.parker.com/saleterms.
- Terms.** All sales of Products by Seller are contingent upon, and will be governed by, these Terms and, these Terms are incorporated into any Quote provided by Seller to any Buyer. Buyer's order for any Products whether communicated to Seller verbally, in writing, by electronic data interface or other electronic commerce, shall constitute acceptance of these Terms. Seller objects to any contrary or additional terms or conditions of Buyer. Reference in Seller's order acknowledgement to Buyer's purchase order or purchase order number shall in no way constitute an acceptance of any of Buyer's terms of purchase. No modification to these Terms will be binding on Seller unless agreed to in writing and signed by an authorized representative of Seller.
- Price; Payment.** The Products set forth in Seller's Quote are offered for sale at the prices indicated in Seller's Quote. Unless otherwise specifically stated in Seller's Quote, prices are valid for thirty (30) days and do not include any sales, use, or other taxes or duties. Seller reserves the right to modify prices at any time to adjust for any raw material price fluctuations. Unless otherwise specified by Seller, all prices are F.C.A. Seller's facility (INCOTERMS 2010). All sales are contingent upon credit approval and payment for all purchases is due thirty (30) days from the date of invoice (or such date as may be specified in the Quote). Unpaid invoices beyond the specified payment date incur interest at the rate of 1.5% per month or the maximum allowable rate under applicable law.
- Shipment; Delivery; Title and Risk of Loss.** All delivery dates are approximate. Seller is not responsible for damages resulting from any delay. Regardless of the manner of shipment, delivery occurs and title and risk of loss or damage pass to Buyer, upon placement of the Products with the shipment carrier at Seller's facility. Unless otherwise agreed, Seller may exercise its judgment in choosing the carrier and means of delivery. No deferral of shipment at Buyer's request beyond the respective indicated shipping date will be made except on terms that will indemnify, defend and hold Seller harmless against all loss and additional expense. Buyer shall be responsible for any additional shipping charges incurred by Seller due to Buyer's acts or omissions.
- Warranty.** The warranty related to the Products is as follows: (i) Goods are warranted against defects in material or workmanship for a period of twelve (12) months from the date of delivery or 2,000 hours of use, whichever occurs first; (ii) Services shall be performed in accordance with generally accepted practices and using the degree of care and skill that is ordinarily exercised and customary in the field to which the Services pertain and are warranted for a period of six (6) months from the completion of the Services by Seller; and (iii) Software is only warranted to perform in accordance with applicable specifications provided by Seller to Buyer for ninety (90) days from the date of delivery or, when downloaded by a Buyer or end-user, from the date of the initial download. All prices are based upon the exclusive limited warranty stated above, and upon the following disclaimer:
DISCLAIMER OF WARRANTY: THIS WARRANTY IS THE SOLE AND ENTIRE WARRANTY PERTAINING TO PRODUCTS. SELLER DISCLAIMS ALL OTHER WARRANTIES, EXPRESS AND IMPLIED, INCLUDING DESIGN, NONINFRINGEMENT, MERCHANTABILITY, AND FITNESS FOR A PARTICULAR PURPOSE. SELLER DOES NOT WARRANT THAT THE SOFTWARE IS ERROR-FREE OR FAULT-TOLERANT, OR THAT BUYER'S USE THEREOF WILL BE SECURE OR UNINTERRUPTED. BUYER AGREES AND ACKNOWLEDGES THAT UNLESS OTHERWISE AUTHORIZED IN WRITING BY SELLER THE SOFTWARE SHALL NOT BE USED IN CONNECTION WITH HAZARDOUS OR HIGH RISK ACTIVITIES OR ENVIRONMENTS. EXCEPT AS EXPRESSLY STATED HEREIN, ALL PRODUCTS ARE PROVIDED "AS IS".
- Claims; Commencement of Actions.** Buyer shall promptly inspect all Products upon receipt. No claims for shortages will be allowed unless reported to the Seller within ten (10) days of delivery. Buyer shall notify Seller of any alleged breach of warranty within thirty (30) days after the date the non-conformance is or should have been discovered by Buyer. Any claim or action against Seller based upon breach of contract or any other theory, including tort, negligence, or otherwise must be commenced within twelve (12) months from the date of the alleged breach or other alleged event, without regard to the date of discovery.
- LIMITATION OF LIABILITY.** IN THE EVENT OF A BREACH OF WARRANTY, SELLER WILL, AT ITS OPTION, REPAIR OR REPLACE THE NON-CONFORMING PRODUCT, RE-PERFORM THE SERVICES, OR REFUND THE PURCHASE PRICE PAID WITHIN A REASONABLE PERIOD OF TIME. **IN NO EVENT IS SELLER LIABLE FOR ANY SPECIAL, INDIRECT, INCIDENTAL OR CONSEQUENTIAL DAMAGES ARISING OUT OF, OR AS THE RESULT OF, THE SALE, DELIVERY, NON-DELIVERY, SERVICING, NON-COMPLETION OF SERVICES, USE, LOSS OF USE OF, OR INABILITY TO USE THE PRODUCTS OR ANY PART THEREOF, LOSS OF DATA, IDENTITY, PRIVACY, OR CONFIDENTIALITY, OR FOR ANY CHARGES OR EXPENSES OF ANY NATURE INCURRED WITHOUT SELLER'S WRITTEN CONSENT, WHETHER BASED IN CONTRACT, TORT OR OTHER LEGAL THEORY. IN NO EVENT SHALL SELLER'S LIABILITY UNDER ANY CLAIM MADE BY BUYER EXCEED THE PURCHASE PRICE PAID FOR THE PRODUCTS.**
- Loss to Buyer's Property.** Any designs, tools, patterns, materials, drawings, confidential information or equipment furnished by Buyer or any other items which are or become Buyer's property, will be considered obsolete and may be destroyed by Seller after two (2) consecutive years have elapsed without Buyer ordering the Products manufactured using such property. Seller shall not be responsible for any loss or damage to such property while it is in Seller's possession or control.
- Special Tooling.** Special Tooling includes but is not limited to tooling, jigs, fixtures and associated manufacturing equipment acquired or necessary to manufacture Products. A tooling charge may be imposed for any Special Tooling. Such Special Tooling shall be and remain Seller's property notwithstanding payment of any charges by Buyer. In no event will Buyer acquire any interest in Special Tooling belonging to Seller that is utilized in the manufacture of the Products, even if such Special Tooling has been specially converted or adapted for such manufacture and notwithstanding any charges paid by Buyer. Unless otherwise agreed, Seller has the right to alter, discard or otherwise dispose of any Special Tooling or other property in its sole discretion at any time.
- Security Interest.** To secure payment of all sums due, Seller retains a security interest in all Products delivered to Buyer and, Buyer's acceptance of these Terms is deemed to be a Security Agreement under the Uniform Commercial Code. Buyer authorizes Seller as its attorney to execute and file on Buyer's behalf all documents Seller deems necessary to perfect its security interest.
- User Responsibility.** The Buyer through its own analysis and testing, is solely responsible for making the final selection of the Products and assuring that all performance, endurance, maintenance, safety and warning requirements of the application of the Products are met. The Buyer must analyze all aspects of the application and follow applicable industry standards, specifications, and other technical information

provided with the Product. If Seller provides Product options based upon data or specifications provided by the Buyer, the Buyer is responsible for determining that such data and specifications are suitable and sufficient for all applications and reasonably foreseeable uses of the Products. In the event the Buyer is not the end-user, Buyer will ensure such end-user complies with this paragraph.

- Use of Products; Indemnity by Buyer.** Buyer shall comply with all instructions, guides and specifications provided by Seller with the Products. **Unauthorized Uses.** If Buyer uses or resells the Products for any uses prohibited in Seller's instructions, guides or specifications, or Buyer otherwise fails to comply with Seller's instructions, guides and specifications, Buyer acknowledges that any such use, resale, or non-compliance is at Buyer's sole risk. Buyer shall indemnify, defend, and hold Seller harmless from any losses, claims, liabilities, damages, lawsuits, judgments and costs (including attorney fees and defense costs), whether for personal injury, property damage, intellectual property infringement or any other claim, brought by or incurred by Buyer, Buyer's employees, or any other person, arising out of: (a) improper selection, application, design, specification or other misuse of Products provided by Seller; (b) any act or omission, negligent or otherwise, of Buyer; (c) Seller's use of patterns, tooling, equipment, plans, drawings, designs or specifications or other information or things furnished by Buyer; (d) damage to the Products from an external cause, repair or attempted repair by anyone other than Seller, failure to follow instructions, guides and specifications provided by Seller, use with goods not provided by Seller, or opening, modifying, deconstructing or tampering with the Products for any reason; or (e) Buyer's failure to comply with these Terms. Seller shall not indemnify Buyer under any circumstance except as otherwise provided in these Terms.
- Cancellations and Changes.** Buyer may not cancel or modify any order for any reason, except with Seller's written consent and upon terms that will indemnify, defend and hold Seller harmless against all direct, incidental and consequential loss or damage. Seller, at any time, may change Product features, specifications, designs and availability.
- Limitation on Assignment.** Buyer may not assign its rights or obligations without the prior written consent of Seller.
- Force Majeure.** Seller does not assume the risk and is not liable for delay or failure to perform any of Seller's obligations by reason of events or circumstances beyond its reasonable control ("Events of Force Majeure"). Events of Force Majeure shall include without limitation: accidents, strikes or labor disputes, acts of any government or government agency, acts of nature, delays or failures in delivery from carriers or suppliers, shortages of materials, or any other cause beyond Seller's reasonable control.
- Waiver and Severability.** Failure to enforce any provision of these Terms will not invalidate that provision; nor will any such failure prejudice Seller's right to enforce that provision in the future. Invalidation of any provision of these Terms by legislation or other rule of law shall not invalidate any other provision herein and, the remaining provisions will remain in full force and effect.
- Termination.** Seller may terminate any agreement governed by or arising from these Terms for any reason and at any time by giving Buyer thirty (30) days prior written notice. Seller may immediately terminate, in writing, if Buyer: (a) breaches any provision of these Terms (b) appoints a trustee, receiver or custodian for all or any part of Buyer's property (c) files a petition for relief in bankruptcy on its own behalf, or one if filed by a third party (d) makes an assignment for the benefit of creditors; or (e) dissolves its business or liquidates all or a majority of its assets.
- Ownership of Software.** Seller retains ownership of all Software supplied to Buyer hereunder. In no event shall Buyer obtain any greater right in and to the Software than a right in the nature of a license limited to the use thereof and subject to compliance with any other terms provided with the Software.
- Indemnity for Infringement of Intellectual Property Rights.** Seller is not liable for infringement of any patents, trademarks, copyrights, trade dress, trade secrets or similar rights ("Intellectual Property Rights") except as provided in this Section. Seller will defend at its expense and will pay the cost of any settlement or damages awarded in an action brought against Buyer based on a third party claim that one or more of the Products sold hereunder infringes the Intellectual Property Rights of a third party in the country of delivery of the Products by the Seller to the Buyer. Seller's obligation to defend and indemnify Buyer is contingent on Buyer notifying Seller within ten (10) days after Buyer becomes aware of any such claim, and Seller having sole control over the defense of the claim including all negotiations for settlement or compromise. If one or more Products sold hereunder is subject to such a claim, Seller may, at its sole expense and option, procure for Buyer the right to continue using the Products, replace or modify the Products so as to render them non-infringing, or offer to accept return of the Products and refund the purchase price less a reasonable allowance for depreciation. Seller has no obligation or liability for any claim of infringement: (i) arising from information provided by Buyer; or (ii) directed to any Products provided hereunder for which the designs are specified in whole or part by Buyer; or (iii) resulting from the modification, combination or use in a system of any Products provided hereunder. The foregoing provisions of this Section constitute Seller's sole and exclusive liability and Buyer's sole and exclusive remedy for such claims of infringement of Intellectual Property Rights.
- Governing Law.** These Terms and the sale and delivery of all Products are deemed to have taken place in, and shall be governed and construed in accordance with, the laws of the State of Ohio, as applicable to contracts executed and wholly performed therein and without regard to conflicts of laws principles. Buyer irrevocably agrees and consents to the exclusive jurisdiction and venue of the courts of Cuyahoga County, Ohio with respect to any dispute, controversy or claim arising out of or relating to the sale and delivery of the Products.
- Entire Agreement.** These Terms, along with the terms set forth in the main body of any Quote, forms the entire agreement between the Buyer and Seller and constitutes the final, complete and exclusive expression of the terms of sale. In the event of a conflict between any term set forth in the main body of a Quote and these Terms, the terms set forth in the main body of the Quote shall prevail. All prior or contemporaneous written or oral agreements or negotiations with respect to the subject matter shall have no effect. These Terms may not be modified unless in writing and signed by an authorized representative of Seller.
- Compliance with Laws.** Buyer agrees to comply with all applicable laws, regulations, and industry and professional standards, including those of the United States of America, and the country or countries in which Buyer may operate, including without limitation the U.S. Foreign Corrupt Practices Act ("FCPA"), the U.S. Anti-Kickback Act ("Anti-Kickback Act"), U.S. and E.U. export control and sanctions laws ("Export Laws"), the U.S. Food Drug and Cosmetic Act ("FDCA"), and the rules and regulations promulgated by the U.S. Food and Drug Administration ("FDA"), each as currently amended. Buyer agrees to indemnify, defend, and hold harmless Seller from the consequences of any violation of such laws, regulations and standards by Buyer, its employees or agents. Buyer acknowledges that it is familiar with all applicable provisions of the FCPA, the Anti-Kickback Act, Export Laws, the FDCA and the FDA and certifies that Buyer will adhere to the requirements thereof and not take any action that would make Seller violate such requirements. Buyer represents and agrees that Buyer will not make any payment or give anything of value, directly or indirectly, to any governmental official, foreign political party or official thereof, candidate for foreign political office, or commercial entity or person, for any improper purpose, including the purpose of influencing such person to purchase Products or otherwise benefit the business of Seller. Buyer further represents and agrees that it will not receive, use, service, transfer or ship any Product from Seller in a manner or for a purpose that violates Export Laws or would cause Seller to be in violation of Export Laws.

5/2017



WARNING - USER RESPONSIBILITY

FAILURE OR IMPROPER SELECTION OR IMPROPER USE OF THE PRODUCTS DESCRIBED HEREIN OR RELATED ITEMS CAN CAUSE DEATH, PERSONAL INJURY AND PROPERTY DAMAGE.

This document and other information from Parker Hannifin Corporation, its subsidiaries and authorized distributors provide product or system options for further investigation by users having technical expertise.

The user, through its own analysis and testing, is solely responsible for making the final selection of the system and components and assuring that all

performance, endurance, maintenance, safety and warning requirements of the application are met. The user must analyze all aspects of the application, follow applicable industry standards, and follow the information concerning the product in the current product catalog and in any other materials provided from Parker or its subsidiaries or authorized distributors.

To the extent that Parker or its subsidiaries or authorized distributors provide component or system options based upon data or specifications provided by the user, the user is responsible for determining that such data and specifications are suitable and sufficient for all applications and reasonably foreseeable uses of the components or systems.

OFFER OF SALE

The items described in this document are hereby offered for sale by Parker Hannifin Corporation, its subsidiaries or its authorized distributors. This offer and its acceptance are governed by the provisions stated in the detailed "Offer of Sale" elsewhere in this document or available at parker.com.



WARNING:

These products can expose you to chemicals including carbon black (airborne and extracts), antimony trioxide, titanium dioxide, silica (crystalline), di(2-ethylhexyl)phthalate, ethylene thiourea, acrylonitrile, 1,3-butadiene, epichlorohydrin, toluenediisocyanate, tetrafluoroethylene, ethylbenzene, formaldehyde, furfuryl alcohol, glass fibers, methyl isobutyl ketone, nickel (metallic and compounds), lead and lead compounds which are known to the State of California to cause cancer; and 1,3-butadiene, epichlorohydrin, di(2-ethylhexyl)phthalate, di-isodecyl phthalate, ethylene thiourea, methyl isobutyl ketone, methanol, toluene, lead and lead compounds which are known to the State of California to cause birth defects and other reproductive harm. For more information go to www.P65Warnings.ca.gov.

Parker Chomerics Contact Locations

To place an order please visit parker.com/chomerics or contact a Customer Service Representative at the following locations:

North America

Parker Chomerics Global Division Headquarters

77 Dragon Court
Woburn, MA
Phone +1 781-935-4850
Fax +781-933-4318
chomailbox@parker.com

Product Disclosure
(ROHS/REACH, Material Declarations, SDS)
choproductdisclosure@parker.com

Europe

Parker Hannifin Ltd Chomerics Division Europe

Unit 6, Century Point
Halifax Road
High Wycombe
Bucks HP12 3SL
UK
Phone +44 1494 455400
Fax +44 14944 55466
chomerics_europe@parker.com

Asia Pacific

**Parker Hannifin
Chomerics Shanghai**
280 Yunqiao Road, Jin Qiao Export
Processing Zone, Shanghai 201206,
China
Phone +86 21 2899 5000
Fax +86 21 2899 5146
chomerics_ap@parker.com

Asia Pacific

**Parker Hannifin
Chomerics Shenzhen**
No.5 Bldg Jinrongda Technological Park
Gangtuo Village, Bantian Longgang District
Shenzhen, 518122, China
Phone +86 755 8974 8558
Fax +86 755 8974 8560
chomerics_ap@parker.com

**Parker Hannifin
Chomerics Kula Lumpur**
Lot 15, Jalan Gudang 16/9
Section 16, Shah Alam
Industrial Estate, 40200 Shah Alam
Selangor, Malaysia
Phone +603 5510 9188
Fax +603 5512 6988
chomerics_ap@parker.com

Penang, Malaysia
No.3, Puncak Perusahaan 1, 13600 Prai,
Penang, Malaysia
Phone +604 398329
Fax +604 3983299
chomerics_ap@parker.com

**Parker Hannifin India Private Limited
Chomerics Division**
Plot No. 41/2, 8th Avenue DTA, Anjur
Village, Mahindra World City, Chengalpattu,
Tamilnadu - 603 004, India
Phone +91 44 67132333
Phone +91 44 67132045
chomerics_ap@parker.com

Manufacturing Facilities

- Woburn, MA, USA
- Hudson, NH, USA
- Fairport, NY, USA
- Monterrey, Mexico
- High Wycombe, UK
- Frépillon, France
- Sadska, Czech Republic
- Kuala Lumpur, Malaysia
- Chennai, India
- Shanghai, China
- Shenzhen, China