

Engineering
Quality
Supply Chain
Assembly
Aftermarket & Production Kitting
Vendor Managed Inventory

Parker ProTech™ Bearing Isolators

Designed For 100% Leak Prevention &
Contaminant Exclusion



**ENGINEERED
SEAL PRODUCTS®**
100% Employee-Owned



espint.com | 319.393.4310

A Solution for the Toughest Applications

ProTech™ Bearing Isolators offer superior protection even in harsh operating environments such as food & paper processing & in gearbox applications.

Unitized Two-Piece, Dynamic Seals

Parker developed the unique ProTech™ design to provide unmatched two-way sealing for zero lubricant leakage & total exclusion of contaminants. This is accomplished by using non-contact labyrinth seal technology. ProTech™ features the most effective labyrinth design for both dirt exclusion & oil retention & is far superior to isolators that rely on internal o-rings or other internal seals.

Unmatched Corrosion Resistance

- Advanced proprietary PTFE compounds mean ProTech™ is well suited for caustic environments such as citric acids found in juice processing & strong sulfides in pulp & paper processing.
- ProTech's superior chemical resistance allows for the standardization of a single material within a plant, eliminating the need to stock duplicate sizes in expensive stainless steel, Hastelloy® or other exotic materials. PTFE is compatible with over 160 chemicals.

Ultimate Gearbox Performance

- ProTech™ 360 is a hybrid design that incorporates an outboard labyrinth for contaminant exclusion & PTFE lip for positive oil retention, even in vertical down applications, making it suitable for demanding gearbox applications
- Upgrading gearboxes that drive cooling tower fans with the ProTech™ 360 design on the input shaft & the ProTech™ LX design (LW without drain port) for the vertical up location is becoming the industry standard for preventing failure due to moisture intrusion.

Solutions For Food Processing Applications

ProTech™'s WD is an economical profile for high volume, disposable equipment such as wash down grade motors & drives. It also greatly reduces maintenance costs & down time in poultry processing applications such as picker hubs. Anti-microbial & FDA materials are readily available.

Prefer A Metallic Isolator?

Parker's Millennium® bearing isolator is based on patented labyrinth seal technology & robust non-contact isolator needs no internal o-ring seal to exclude heavy water spray. No internal seal means zero wear & longer life. Severe oil splash retention grooves, unitized cartridge design & tool-free installation are also standard features.



GEARBOXES

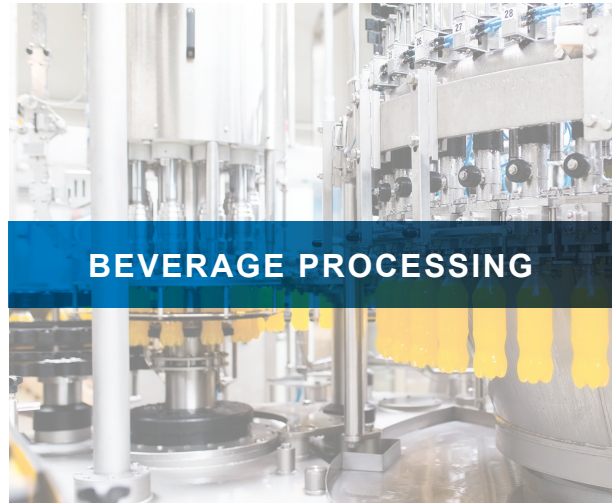

BEVERAGE PROCESSING



PAPER & PULP PROCESSING



FOOD PROCESSING

Upgrade From Standard Lip Seals

Bearing isolators are an upgrade from standard lip seals, however when one considers the total cost of the sealing system over the total life span, it is well worth it for key equipment such as pumps, motors, gear boxes, & split pillow blocks. The cost of downtime in today's manufacturing environment has been the primary driver behind companies' decisions to convert from lip seals to bearing isolator-type seals. Standard lip seals have a typical life of 3,000 to 5,000 hours. With true non-contact ProTech™ designs there is nothing to wear out. With a bearing isolator solution, the seal is no longer the limiting factor for the bearings reaching the basic life rating stated by bearing manufacturers (L10 rating).

Cost Savings Realized By

- Less unplanned downtime
- Lower maintenance expenses with fewer rebuilds
- Lower torque consumption which results in lower energy usage
- In some cases, the energy savings alone offsets upgrade costs

ProTech™ Seal Design

FEATURES	BENEFITS
Non-Contact Design	<ul style="list-style-type: none">• Virtually no torque consumption• Will not wear or groove shafts
Two-Piece Unitized Construction	<ul style="list-style-type: none">• Complete exclusion of dust & water• Zero oil leakage• Fewer components & ease of installation
Accommodates Greatest Axial Movement	<ul style="list-style-type: none">• Reduces a major factor causing labyrinth seal leakage
Fluoroelastomer O-rings	<ul style="list-style-type: none">• Static elastomer seal for the most severe services
No Lubrication Required	<ul style="list-style-type: none">• Can run dry because of non-contact design
High Shaft Speeds	<ul style="list-style-type: none">• Operates far beyond shaft speed limits of standard radial lip seals• Liberal specifications for shaft & bore finish result in low shaft cost
Precision-Machined Seal	<ul style="list-style-type: none">• Allows retrofit of most bore & shaft combinations• No tooling charges

Extreme Test Results

Material:	PTFE	Bronze	PTFE	Bronze
Expulsion Method:	Single-Port	Single-Port	Multi-Port	Single-Port
Design Type:	2-Pc. Unitized	2-Pc. Non-Unitized	3-Pc. Unitized	3-Pc. Unitized
Brand:	Parker	Brand A	Brand B	Brand C
Oil Leak Test	PASS	FAIL	PASS	FAIL
Water Pressure Test	PASS	FAIL	FAIL	FAIL
Dust Test	PASS	PASS	FAIL	FAIL

- **Oil leakage test:** ProTech™ & other seals were subjected to critical oil seal testing using a machine built to SAE J110 standards. One-hundred hour tests were conducted with severe oil splash.
- **Water exclusion test:** The test machine was modified by mounting five nozzles at various positions relative to the exterior of the seal to simulate severe external wash down. Using water at pressures of 30 to 62 psi, these nozzles individually sprayed each seal from a distance of 3" in both a static mode & while the shaft rotated at various speeds up to 3525 rpm. The nozzles tried to force water past the seal for nearly two hours.
- **Dust exclusion test:** The test machine was modified with an enclosed chamber containing a large quantity of fine dust and sand which was vigorously agitated with the chamber attached to the outside of each seal area. The equipment operated at speeds up to 3525 rpm for a period of 70 hours in an environment that was literally a dense dust storm.

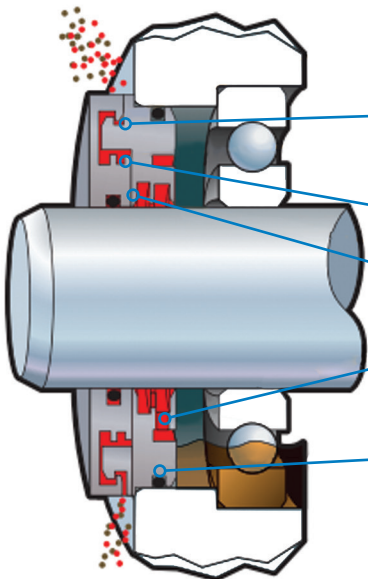

- First to offer two-piece unitized patented design - locks seal together & won't wear like internal o-rings, PTFE elements or other locking rings.
- Contaminant exclusion relies on labyrinth technology, not an internal seal.
- Superior chemical resistance provided by proprietary PTFE materials.
- Setting the standard for oil retention. Inboard labyrinth is the most efficient design for retaining oil splash. Far superior to single groove concept.
- External o-rings provide press fit at shaft & seal housing for zero wear. Also allows for easy installation

First Isolator UL tested to IEEE 841, meets or exceeds IP55, IP56, IP66, IP69k & API 610

ProTech™ "LW"

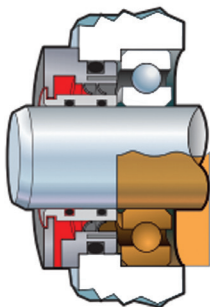

ProTech™ 360

The first & only hybrid isolator designed for flooded oil & oil mist applications. Used by numerous gearbox OEMs as standard equipment, the ProTech™ 360 features internal dual PTFE lips on an internal SS sleeve for zero shaft wear.

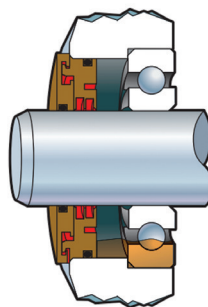

ProTech™ Millennium®

The first & only metallic isolator that is unitized without internal o-rings or locking rings. Millennium's patented labyrinth technology does not rely on a simple o-ring for bearing protection.

Standard Designs

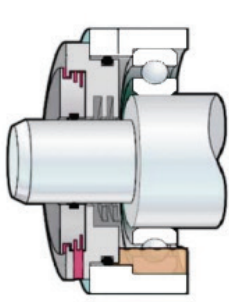

LS Flanges

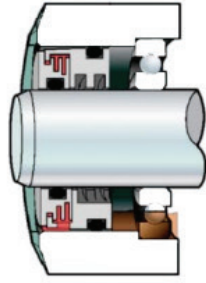

LN Non-Flanged

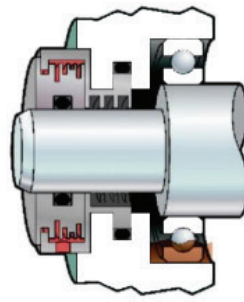

LB Pillow Block

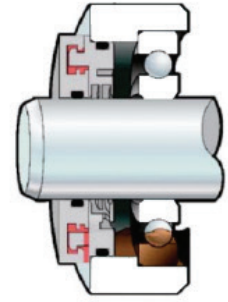

LW Flanged

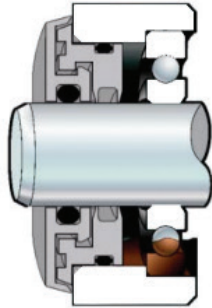

WD Narrow

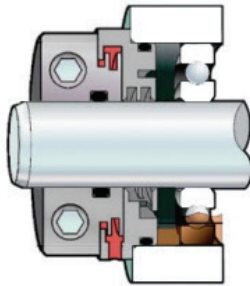

SL Split

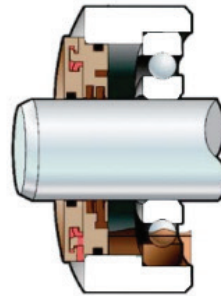

ML Flanged
Millennium®

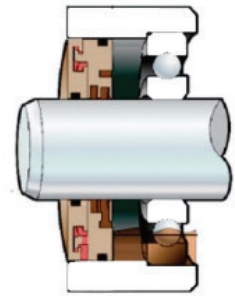

MN Non-Flanged
Millennium®

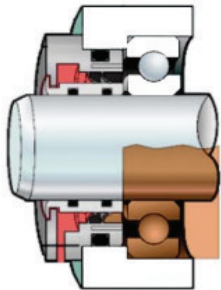

FS 360 Flanged

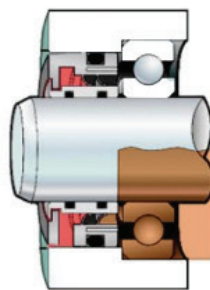

FN 360 Non-Flanged

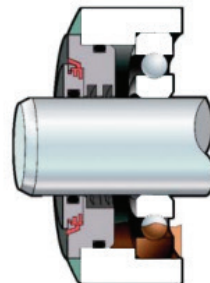

LD Multi Port

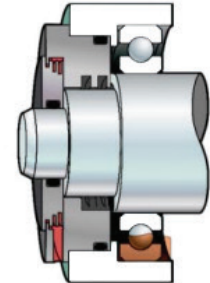

LM Step Shaft

Custom Designs

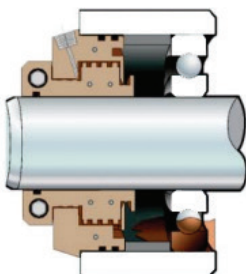

Split Air Purge

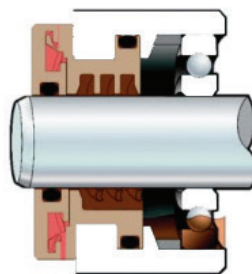

Turbine

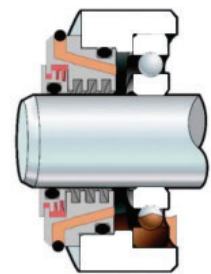

Grease Purge



Premier Parker STC

For over 50 years, Engineered Seal Products has partnered with Parker Seals. **ESP is proud to be one of the FEW Premier Distributors** to qualify as a "Parker Seal Technology Center (STC)".

- **Proven Engineering Capability**
- **Expert Material & Technical Support**
- **ISO Quality Approval**
- **Strong Financial Track Record**



**ENGINEERED
SEAL PRODUCTS®**
100% Employee-Owned

espint.com | 319.393.4310